

Introduction

This User's Reference guide explains how to use your D/A1 size or A0+/E+ size **HP DesignJet 800PS** Printer.

The Introduction Tab contains these topics:

- [Using this Guide](#)
Contains information on how to use this guide. There is an explanation of when you should use it and what each of the navigation buttons do when you click on them.
- [Introducing Your HP DesignJet 800PS Printer](#)
Contains a brief overview of the printer. It contains information about the printer's features and what is included with the printer.
- [Front View of Printer](#)
Contains a view of the front of the printer showing the location of the printer's consumable items.
- [Printer Connections](#)
Shows all the connections to the printer: power, [parallel interface](#), [USB](#) and network interface.





Using this Guide

These topics detail the contents of the *User's Reference Guide*, provide information on associated publications and give the source of any other related material concerning your printer.

- [How to Use this Guide](#)
Explains how to use and navigate through the *User's Reference Guide*
- [Related Information](#)
The associated publications and information that are available for your printer.



How to Use this Guide

This User's Reference guide explains the details for using both the D/A1 size and A0+/E+ size **HP DesignJet 800PS** Printers.

This guide is designed as a detailed reference guide to your printer. For more day-to-day guidance you can refer to the Pocket Guide. This can be found in a slot at the right side of the printer.

The “Tabs”

There are seven “Tabs” at the top of this guide. Each tab contains information about the printer. The first page of every tab will explain what information you can expect to find and where to obtain related information.

The Buttons

To navigate around the User's Reference Guide use the buttons on each side of the screen. See [User's Reference Guide Navigation](#).

Animation

In some cases there is an animation that shows you how to perform the procedure.

Click on this button to start the animation.



[Related Topics](#)



Related Information

- The *Setup Poster*
Step-by-step information on how to prepare your printer for use (came with your printer).
- The *Pocket Guide*
Information that you are most likely to need for printer operation on a day-by-day basis, such as loading paper or replacing ink supplies (came with your printer and located in a slot on the right hand side of the printer).
- The *Repacking Poster*
Detailed instructions on how to repack your printer its original packing (available from www.hp.com/go/designjet).
- Web Page
Also you can visit us on our web page: www.hp.com/go/designjet.

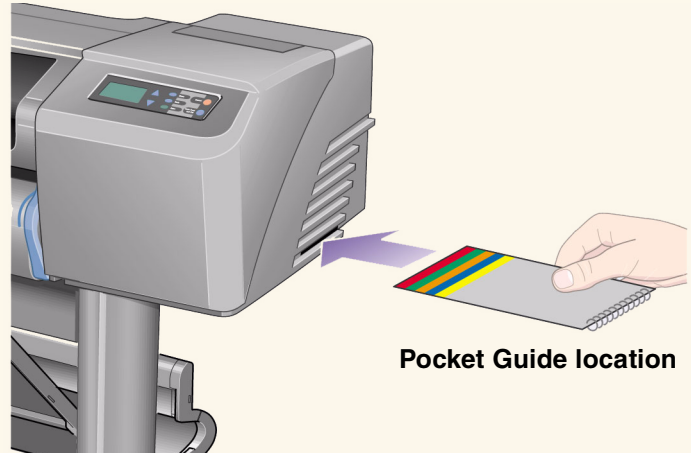



User's Reference Guide Navigation

The buttons on each side of the screen allow you to rapidly navigate through this document.

Home



To return to the Welcome Screen of the *Using Your Printer* CD-ROM, click the Home button.

To exit this document and quit the Acrobat Reader application, click the Exit Button.

Exit



Back



To retrace your path within this document, click the Back button.

To print pages of the document, click the Print button.

Print



Previous Page



To go to the previous page, click the Previous Page button.

To go to the next page, click the Next Page button.

Next Page



Introducing Your HP DesignJet 800PS Printer

- [Your Printer's Main Features](#)
A general overview of the major features of your printer.
- [HP Ink Supplies](#)
A description of the HP Ink Supplies required for your printer.
- [Print Resolution](#)
Specifications of the print resolution for your printer.
- [Media](#)
A description of the different types of media available for your printer.
- [User Interface](#)
A description of the printer's User Interface.
- [Memory](#)
Details of internal memory and memory options available with your printer.
- [Drivers](#)
Details of the [drivers](#) delivered with your printer.



Your Printer's Main Features

The **HP DesignJet 800PS** printing system is specially designed for medium work-groups in the advertising agencies, in-house graphic departments that specialize in packaging, point-of-sale material and event signs as well as all other graphics applications.

For the complete printing solution, HP also offers a wide range of media including HP Satin Poster Paper, ideal for retail point-of-purchase signs and special occasion posters as well as HP High-Gloss Photo Paper, designed to produce best quality images with an ultra-smooth glossy finish. And with the HP Complementary Media Program, HP provides users with a wide spectrum of choice and flexibility in their media selection.

The **HP DesignJet 800PS** printer comes in two sizes: A0+/E+ size (42 inches/1066.8 mm) and D/A1 size (24 inches/609.6 mm) models. Both models have roll-feed capabilities. The A0+/E+ size model also includes legs and a media bin.

- **Ultimate Photo Image Quality:** The **HP DesignJet 800PS** printing system has a true resolution of up to 2400x1200-dpi on glossy paper, enabling graphic designers to proof, print and present (from letter to poster size) the ultimate in photo image quality. Light pastels to natural skin tones and bright, vivid colors are achieved using the HP one-half inch/12.7mm wide printhead combined with HP color layering technology. In addition, the **HP DesignJet 800PS** provides excellent line quality.
- **Color Accuracy:** The **HP DesignJet 800PS** printer reproduces accurate colors without any manual calibration or adjustment. Color emulation and Automatic [PANTONE](#) calibration mean that graphic professionals can work efficiently without having to retouch colors. In addition, the **HP DesignJet 800PS** printer automatically substitutes [CMYK](#) values for PANTONE values.



[More...](#)



- **Connectivity:** The **HP DesignJet 800PS** printer includes [PostScript](#) drivers for Macintosh and Windows and [HP-GL/2](#) drivers for AutoCad® and Windows. In addition, the printer includes USB and Parallel ports and a powerful HP JetDirect 10/100 Base-TX network card. Using the network card, the data from the graphic professional's computer is transferred to the “virtual computer”, an internal PostScript RIP, within the **HP DesignJet 800PS** printer and immediately frees the data from the computer while processing it quickly.
- **Speed:** The **HP DesignJet 800PS** printer delivers speeds of 85ft²/hour and color images on glossy media are printed up to two times faster than its predecessor the, the HP DesignJet 700 series printers. Because the printer contains a virtual computer and printing is continuous, data is received by the network card and quickly processes and prints using embedded processors and large memory (160MB RAM and 6GB hard disk) included within the printer.
- **Complementary Media Program ([CMP](#)):** The CMP helps HP customers grow their businesses by referencing third-party printing material choices to ensure maximum HP DesignJet printer flexibility and printing solutions.



HP Ink Supplies

HP Ink Supplies for your printer contain two components: printheads and ink cartridges. Your **HP DesignJet 800PS** printer uses the following HP Ink Supplies:

- Black Ink Cartridges are HP No 10 Supplies.
- Cyan, Magenta and Yellow Cartridges are HP No 82 Supplies.
- All Printheads are HP No 11 Supplies.

Each 600-dpi thermal inkjet printhead applies thousands of ink droplets onto the paper. The printer automatically refills the printhead as it prints, enabling continuous uninterrupted printing. The ink is supplied to each printhead from a separate large capacity ink cartridge.

There is more information available in a pamphlet which comes with the printheads and in [Print Times for a Selected Print Quality](#).



Print Resolution

Your **HP DesignJet 800PS** printer provides two different print modes that change the print resolutions of each of the print quality modes. These different print modes are optimized for: Line Drawings/Text or Images.

You can then choose between three levels of print quality for each of the print modes: Best, Normal or Fast from your software or from the printer's front panel.

With the best mode selected you have an additional selection available to provide maximum detail for your printed image by increasing the resolution of your job above the default resolution.

Print Quality Setting	Optimized for Line Drawing/Text		Optimized for Images	
	Resolution in dpi		Resolution in dpi	
	Render	Halftone	Render	Halftone
Fast	300x300	600x300	150x150	600x300
Normal	600x600	600x600	300x300	600x600
Best (default)	600x600	600x600	600x600	600x600
Best (maximum detail)	600x600	1200x600	1200x1200	2400x1200 ^a

a. Glossy Photo Media Only

Use **Fast** to get draft copies of your prints at maximum throughput. **Normal** is optimized so that you get the best line quality with the fastest throughput. Select **Best** if you want to get the best quality for images and renderings.



Media

You can print on roll media or sheet media up to 42 inches (1066.8 mm) wide with the A0+/E+ size **HP DesignJet 800PS** printer and up to 24 inches (609.6 mm) with the D/A1 size model.

The following media types are supported on the **HP DesignJet 800PS** printer:

- [HP Bright White Inkjet Paper \(Bond\)](#)
- [HP Vellum](#)
- [HP Natural Tracing Paper](#)
- [HP Coated Paper](#)
- [HP Heavyweight Coated Paper](#)
- [HP Matte film](#)
- [HP High-Gloss Photo Paper](#)
- [HP Semi-Gloss Photo Paper](#)
- [HP Paper-Based Semi-Gloss](#)
- [HP Clear film](#)
- [HP Translucent bond](#)
- [HP Studio Canvas](#)
- [HP Satin Poster Paper](#)
- [HP Banners with Tyvek®](#)
- [HP Colorfast Adhesive Vinyl](#)



User Interface

The printer's front panel includes an easy-to-use interface with a display, giving you access to a comprehensive set of printer functions.

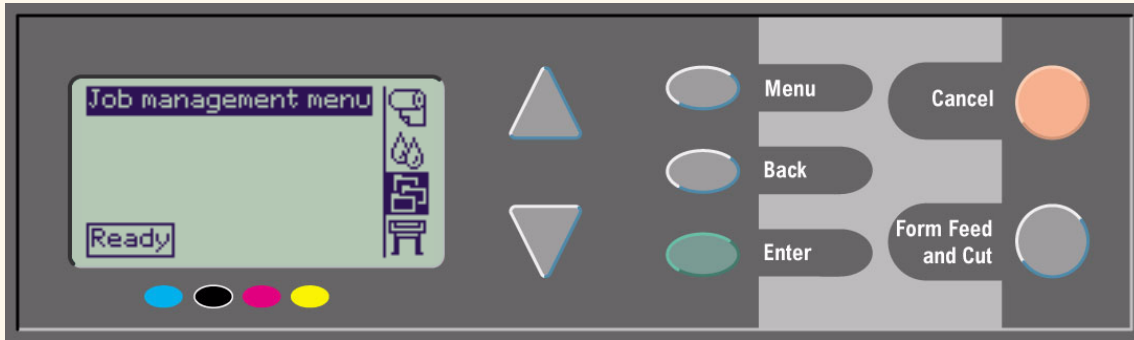

See [Navigating the Menu System](#), for a short tutorial to teach you how to navigate through the menus and a description of internal prints.



Memory

The D/A1 size and A0+/E+ size **HP DesignJet 800PS** printers come with 160MB of Random Access Memory (RAM) memory. In addition to this memory, the printer has a 6GB internal hard disk drive used as extended memory for PostScript and [HP-GL/2](#) rendering and print management.



Drivers

Always use the right driver (configured correctly) for the combination of your [application](#) software and your printer to ensure that your printer prints exactly what you were expecting in terms of: size, position, orientation, color and quality.

NOTE: Many software applications include their own drivers.

Your **HP DesignJet 800PS** printer comes supplied with:

- Adobe PostScript® drivers for Macintosh® (QuickDraw™)
- Adobe PostScript® drivers for Microsoft® Windows™ applications
- Windows drivers
- AutoCAD drivers for Windows.

NOTE: If AutoCAD drivers are available for the specific AutoCAD release you are using, it is strongly recommended that you install them to print from AutoCAD.



Front View of Printer

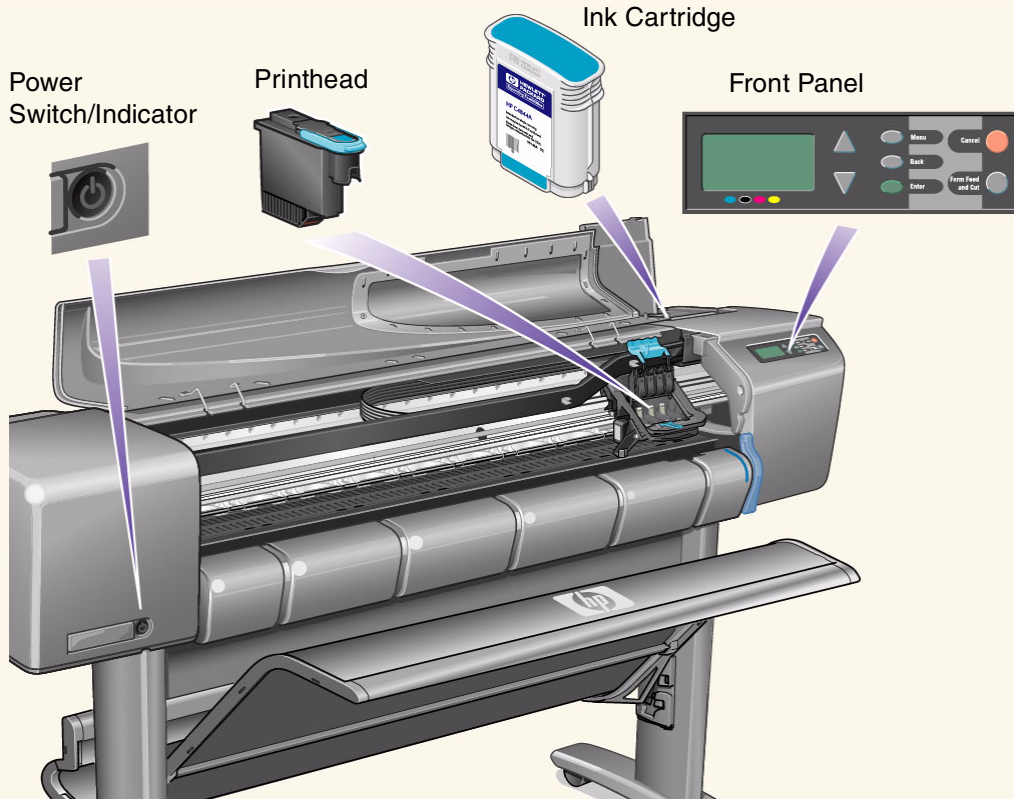

Printer Connections

Your **HP DesignJet 800PS** printer can be connected directly to your computer via the traditional parallel interface or through the Universal Serial Bus ([USB](#)) port.

For Local Area Network ([LAN](#)) connection your printer has an HP JetDirect Print Server Fast Ethernet 10/100 base TX network interface card.

See the *Setup Poster* for information on connecting your printer to a computer or network.

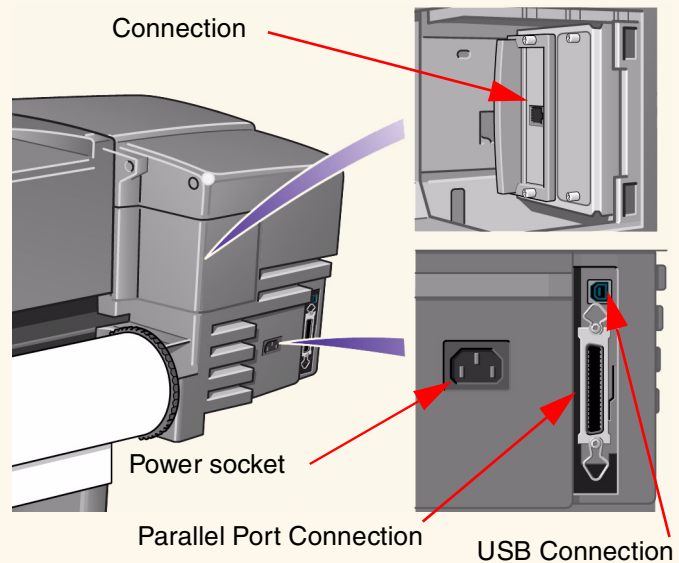

Media & Ink

The D/A1 size and A0+/E+ size format **HP DesignJet 800PS** Printers use a variety of media. The recommended media is engineered to use with your printer and your printer's ink system to give you the best results.

The Media & Ink Tab contains these topics:

- [Media Choice](#) explains how to choose the correct media type. Choosing the correct paper type for your needs is an essential step in ensuring good image quality.
- [Roll Media](#) details the procedures used for loading and unloading your roll media.
- [Sheet Media](#) details the procedures used for loading and unloading your sheet media.
- [Ink System](#) gives you an overview of the printer's ink system, with some warnings and precautions for its optimum use.
- [Ink Cartridges](#) details the procedures used for: obtaining information, interpreting errors, checking levels and replacing ink cartridges.
- [Printheads](#) details the procedures used for: obtaining information, interpreting errors, replacing printheads and aligning printheads.



Media Choice

- [Choosing Paper or Other Media](#)

Your printer supports several types of paper. Choosing the best paper type for your needs is an essential step in ensuring good image quality. These topics help you to select the best media for your particular printing task.

- [Paper Types](#)

Provides detailed information concerning the different media types available for your printer. This includes information on: the types of paper supported, their physical characteristics, quality selection, handling and how to obtain information.

- [Print Times for a Selected Print Quality](#)

Typical Printing Times for color and black lines and images on different types of paper.

- [Printable Area](#)

The dimensions for all the printable areas for all paper and other types of media formats.

- [ICC Profiles](#)

International Color Consortium (ICC) device profiles downloading instructions.



Choosing Paper or Other Media

For best printing results, use only genuine Hewlett-Packard paper or other type of media, whose reliability and performance have been developed and thoroughly tested. All Hewlett-Packard printing components (printer, ink system, and paper/other media) have been designed to work together to give trouble-free performance and optimal image quality.

For detailed information on Hewlett-Packard paper, see [Paper Types](#).

You should also take note of some important points about paper and other types of media:

- This printer supports many types of paper. However, the quality of some images may be reduced if you do not use the correct paper for your application. For example images with large regions of intense color, where many ink drops are needed to fully saturate the color, will not print well on HP Bright White InkJet Paper. On HP [Coated paper](#), the same images might cause the paper to wrinkle and then come into contact with the printheads, smearing your print and risking damage to the printhead. See [Combinations of Media Type and Print Quality Selection](#).
- Whenever you load a roll or a sheet, the printer's front-panel display prompts you to specify the paper type you are loading. It is absolutely essential to specify this correctly for good image quality. The [Physical Characteristics of Paper Types](#) table gives you all the information you need. If paper is already loaded and you are unsure which paper type was specified, go to the Paper Menu and press Enter, see [Obtaining Roll or Sheet Paper Information](#).
- Make sure the appropriate print-quality setting (**Best, Normal or Fast**) is selected. You can set the print quality either from your software or from the printer's front panel (software driver settings override any print-quality settings made on the front panel). The combination of paper type and print-quality settings tells the printer how to place the ink on the paper—for example, the ink density, dithering method, and number of passes of the printheads. For more details, see [Combinations of Media Type and Print Quality Selection](#).
- Included with this printer is the *Hewlett-Packard Printing Materials* catalog which gives ordering details for Hewlett-Packard paper supplies. To get the latest version of this document, contact your local Hewlett-Packard Sales and Support office.



Paper Types

The following topics address the various types of media available, their particular use and how to obtain information about them.

- [Physical Characteristics of Paper Types](#)
Details the physical characteristics of each of the supported paper types.
- [Combinations of Media Type and Print Quality Selection](#)
Gives guide lines for selecting the correct Print Quality selection for the type of paper or other type of media you are using.
- [Handling Your Paper or Type of Media](#)
Explains the precautions to take when handling paper or other type of media.
- [Obtaining Roll or Sheet Paper Information](#)



Physical Characteristics of Paper Types

The following table lists the physical characteristics and selection numbers of supported HP Premium Printing Material. Always print on the image side with the special coating. Image side faces outward on roll products from Hewlett-Packard.

Physical Characteristics of Paper and Other Media

HP Premium Printing Material	24 inch 610 mm	36 inch 914 mm	42 inch 1067 mm
HP Bright White Inkjet Paper (Bond) 24 lb. (90g/m ²) - 150 ft. (45m)	C1860A ^a C6035A ^b	C1861A ^a C6036A ^b	
HP Vellum 3 mil (75g/m ²) - 150 ft. (45m)	C3862A	C3861A	
HP Natural Tracing Paper 3 mil (90g/m ²) - 150 ft. (45m)	C3869A	C3868A	
HP Coated Paper 26 lb. (98g/m ²) - 150 ft. (45m)	C6019B	C6020B	C6559B ^a C6567B ^b
HP Heavyweight Coated Paper 35 lb. (130g/m ²) - 100 ft. (30m)	C6029C	C6030C	C6569C
HP Matte film 5 mil (198g/m ²) - 120 ft. (36m)	51642A	51642B	
HP High-Gloss Photo Paper 8 mil (207g/m ²) - 100 ft. (30m)	C6813A	C6814A	

[Click on the Next Page Icon to see more Paper and Other Media Types](#)



Physical Characteristics of Paper and Other Media (Continued)

HP Premium Printing Material	24 inch 610 mm	36 inch 914 mm	42 inch 1067 mm
HP High-Gloss Photo Paper 6 mil (158g/m ²) - 100 ft. (30m)	C3882A	C3881A	
HP Semi-Gloss Photo Paper 6 mil (158g/m ²) - 100 ft. (30m)	C3884A	C3883A	
HP Paper-Based Semi-Gloss 6 mil (158g/m ²) - 100 ft. (30m)	C6782A	C6783A	
HP Clear film 4 mil (174g/m ²) - 75 ft. (22m)	C3876A	C3875A	
HP Translucent bond 3 mil (67g/m ²) - 75 ft. (45m)	C3860A	C3859A	
HP Studio Canvas 20 mil (368g/m ²) - 35 ft. (10m)		C6771A	
HP Satin Poster Paper 5.5 mil (162g/m ²) - 100 ft. (30m)		C7011A	
HP Banners with Tyvek® 10 mil (140g/m ²) - 50 ft. (15m)	C6786A	C6787A	
HP Colorfast Adhesive Vinyl 10 mil (140g/m ²) - 50 ft. (15m)		C6775A	

- a. Available in United States, Canada & Latin America
- b. Available in Europe, Asia & Japan

[Additional Information About Paper Types](#)



Additional Information About Paper Types

The following HP Premium Printing Material can be used to perform the printhead alignment, see [Printhead Alignment](#).

- HP Bright White Inkjet Paper (Bond)
- HP Coated Paper
- HP Heavyweight Coated Paper
- HP High-Gloss Photo Paper
- HP Satin Poster Paper

You can also use Plain Paper in addition to the above.

To order any of the HP Premium Printing Material see the pamphlet *Hewlett-Packard Printing Materials*.

From time to time, new paper types may become available. For up-to-date information, please contact your Hewlett-Packard dealer, local Hewlett-Packard Sales and Support Office or the [DesignJet Online](#) web site.



Combinations of Media Type and Print Quality Selection

Use the following tables, given by application, to guide you when choosing your paper and selecting the print quality setting (**Fast**, **Normal**, **Best**).

- [CAD Drawings—Mono](#)
- [CAD Drawings & GIS—COLOR \(Lines and low density\)](#)
- [CAD Rendering, GIS & Images—COLOR and CAD \(high ink density\)](#)

As a general guide:

- Use **Fast** to get draft copies of your prints at maximum throughput
- **Normal** is optimized so that you get the best line quality with the fastest throughput
- Select **Best** if you want to get the best quality for images and renderings



CAD Drawings—Mono

The following table lists the recommended print quality settings for specific usage with typical media.

Supported Paper Types—MONO

Usage	Typical Media Selection	Recommended Print Quality Setting
Drafts	Plain Paper Bright Inkjet Paper Natural Tracing Paper Translucent Bond	Fast or normal
Final Versions	Plain Paper Bright Inkjet Paper Natural Tracing Paper Translucent Bond Coated paper Heavy Coated Paper Matte Film Clear film	Normal or Best
Archives	Vellum Matte Film Clear Film	Best
Diazo	Translucent Bond Natural Tracing Paper Vellum Matte Film	Normal or Best



CAD Drawings & GIS—COLOR (Lines and low density)

The following table lists the recommended print quality settings for specific usage with typical media.

Supported Paper Types—COLOR

Usage	Typical Media Selection	Recommended Print Quality Setting
Drafts	Plain Paper Bright Inkjet Paper Natural Tracing Paper Translucent Bond	Fast or Normal
Final Versions	Plain Paper Bright Inkjet Paper Coated paper Heavy Coated Paper Matte Film Clear film	Normal or Best
Archives	Matte Film Clear Film	Best
Transparencies	Clear Film	Normal or Best



CAD Rendering, GIS & Images—COLOR and CAD (high ink density)

The following table lists the recommended print quality settings for specific usage with typical media.

Supported Paper Types—COLOR and CAD

Usage	Typical Media Selection	Recommended Print Quality Setting
Matte Paper	Heavy Coated Paper	Normal or Best
Glossy	High Gloss Photo Paper	Normal or Best
Transparencies	Clear Film	Best



Handling Your Paper or Type of Media

Take the following precautions when handling paper or other type of media:

- Handle film and glossy paper by the edges or wear cotton gloves. Skin oils can interact with the ink and cause it to smear.
- Although the ink systems supplied with this printer have good light fastness, colors will eventually fade or change if exposed to sunlight over a long period of time.
- Rewrap partially used rolls if they are not being used and do not stack rolls.
- Always keep unused rolls in their plastic wrappings to prevent discoloration.



Obtaining Roll or Sheet Paper Information

If roll media or sheet media is loaded, the type of media is displayed when you select the **Paper** menu on the front panel.

Bright White Inkjet Paper
 Plain Paper
 Vellum
 Natural Tracing Paper
 Translucent Bond
 Clear Film
 Matte Film
 Coated Paper
 Heavy Coated Paper
 High-Gloss Photo
 Canvas
 Poster Paper



Roll or Sheet

If there is no paper loaded the front panel display shows the following message and you will need to load roll or sheet media.

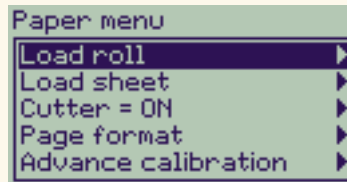

Print Times for a Selected Print Quality

The following table lists some Typical Printing Times D/A1 size.

Typical Printing Times

Print Quality	Time (in seconds)			
	Mono Lines on Bond	Color Lines on Coated Paper	Images on Coated Paper	Images on Glossy Paper
Fast	69	96	234	480
Normal	216	216	550	690
Best	360	285	940	990



[More Printing Times](#)



Printable Area

The following topics detail the printable areas for each of the different paper size systems:

- [ANSI Paper](#)
The American National Standards Institute imperial paper sizing system.
- [Architectural Paper](#)
The Architectural paper sizing system.
- [ISO Paper](#)
The International Standards Organization metric paper sizing system which is commonly size system used in Europe.



ANSI Paper

The following table lists the printable area for the [ANSI paper](#) size system.

The left & right margins are 0.2 inches (5 mm) and the leading & trailing edge margins are 0.7 inches (17 mm).

Where: Printable area = Paper Size – Margins

Printable Areas for ANSI paper

Paper Size	Orientation of Paper in Printer	Printable area (Width x Height) by Image Orientation							
		Inches				Millimeters			
		Landscape		Portrait		Landscape		Portrait	
		Width	Height	Width	Height	Width	Height	Width	Height
A	Portrait	9.7	8.1	8.1	9.7	245	206	206	245
	Landscape	7.2	10.6	10.6	7.2	182	269	269	182
B	Portrait	15.7	10.6	10.6	15.7	398	269	269	398
	Landscape	9.7	16.6	16.6	9.7	245	422	422	245
C	Portrait	20.7	16.6	16.6	20.7	525	422	422	525
	Landscape	15.7	21.6	21.6	15.7	398	549	549	398
D	Portrait	32.7	21.6	21.6	32.7	830	549	549	830
	Landscape	20.7	33.6	33.6	20.7	525	854	854	525
E	Portrait	N/A		33.6	42.7	N/A		854	1084
	Landscape	32.7	43.6	N/A		830	1108	N/A	

 Indicates this printable area is only available if you are using the A0+/E+ size format HP DesignJet 800PS printer

Architectural Paper

The following table lists the printable area for the [Architectural paper](#) size system.

The left & right margins are 0.2 inches (5 mm) and the leading & trailing edge margins are 0.7 inches (17 mm).

Where: Printable area = Paper Size – Margins .

Printable Areas for Architectural paper

Paper Size	Orientation of Paper in Printer	Printable area (Width x Height) by Image Orientation							
		Inches				Millimeters			
		Landscape		Portrait		Landscape		Portrait	
		Width	Height	Width	Height	Width	Height	Width	Height
C	Portrait	22.7	17.6	17.6	22.7	576	447	447	576
	Landscape	16.7	23.6	23.6	16.7	423	600	600	423
D	Portrait	34.7	23.6	23.6	34.7	880	600	600	880
	Landscape	22.7	35.6	35.6	22.7	576	904	904	576
E1	Portrait	40.7	29.6	29.6	40.7	1033	752	752	1033
	Landscape	28.7	41.6	41.6	28.7	728	1057	1057	728
E	Portrait	N/A		35.6	46.7	N/A		904	1185
	Landscape	34.7	47.6	N/A		880	1209	N/A	



Indicates this printable area is only available if you are using the A0+/E+ size format
HP DesignJet 800PS printer



ISO Paper

The following table lists the printable area for the [ISO paper](#) size system.

The left & right margins are 0.2 inches (5 mm) and the leading & trailing edge margins are 0.7 inches (17 mm).

Where: Printable area = Paper Size – Margins

Printable Areas for ISO paper

Paper Size	Orientation of Paper in Printer	Printable area (Width x Height) by Image Orientation							
		Inches				Millimeters			
		Landscape		Portrait		Landscape		Portrait	
		Width	Height	Width	Height	Width	Height	Width	Height
A4	Portrait	10.4	7.9	7.9	10.4	263	200	200	263
	Landscape	6.9	11.3	11.3	6.9	176	287	287	176
A3	Portrait	15.2	11.3	11.3	15.2	386	287	287	386
	Landscape	10.4	16.1	16.1	10.4	263	410	410	263
A2	Portrait	22.0	16.1	16.1	22.0	560	410	410	560
	Landscape	15.2	23.0	23.0	15.2	386	584	584	386
A1	Portrait	31.7	23.0	23.0	31.7	806	584	584	806
	Landscape	22.0	32.7	32.7	22.0	560	830	830	560
A0	Portrait	N/A		32.7	45.4	N/A		830	1154



Indicates this printable area is only available if you are using the A0+/E+ size format
HP DesignJet 800PS printer



ICC Profiles

Using HP-provided ICC Profiles for the HP DesignJet media assures optimal color reproduction on your **HP DesignJet 800PS** printer. To use an ICC Profile you must first download the profiles. These profiles can be found for a particular printer's driver page. Begin by clicking the CD icon for drivers on the main page of <http://www.hp.com/go/designjet> and select "Printing Materials." This will lead you to the drivers and ICC Profiles for a particular printer.

You download all the ICC Profiles for a specific printer and ink combination in one self-extracting archive. You will find ICC Profiles for all HP Premium Printing Material media including HP Studio Canvas, HP Colorfast Adhesive Vinyl, and HP Banners with Tyvek®.



Roll Media

The following procedures are described in detail, with animations where appropriate:

- [Installing a New Roll on the Printer](#)
- [Loading Roll Media](#)
- [Unloading Roll Media](#)
- [Removing Roll Media from the Spindle](#)
- [Cutter Replacement](#)



Installing a New Roll on the Printer

The animation sequence shows how to install a new roll of paper on the printer.

CAUTION: Make sure the printer wheels are locked (the brake lever on each wheel is pressed Down) to prevent the printer from moving.

If you are a regular user of different types of roll paper, you can change the paper quicker if you have more than one spindle. This allows you to do the following:

1. Pre-load the different types of paper onto the spindles.
2. Remove and replace the spindle with the new type of paper.

NOTE: Additional spindles are available from Hewlett Packard as accessories.

Click on this  icon to run the animation sequence.

A [printable version](#) of the sequence is also available so that you can take the key illustrations to the printer, if it's remote from your computer.

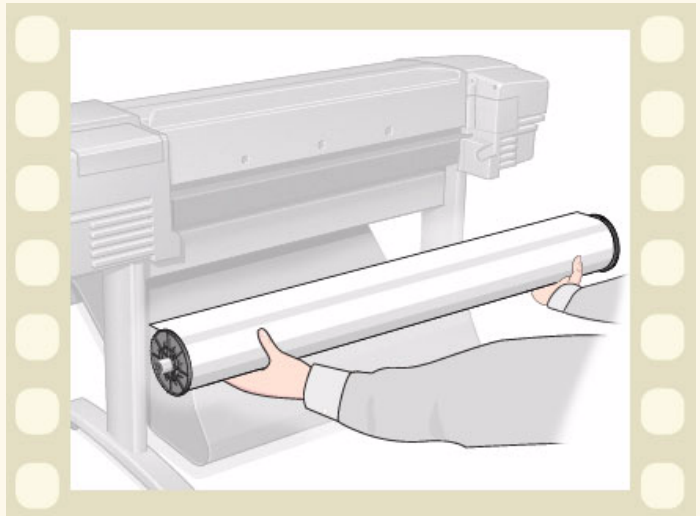

Loading Roll Media

The animation sequence shows how to load a new roll of paper on the printer.

NOTE: You must have [installed](#) a new roll of paper on the printer before you can load it.

The front-panel menu items are:

Select (using the  keys)

Then Press:

- | | |
|---------------------|-------|
| 1. Paper | Enter |
| 2. Load Roll | Enter |
| 3. Select Roll Type | Enter |

Click on the  icon to run the animation sequence.

A [printable version](#) of the sequence is also available so that you can take the key illustrations to the printer, if it's remote from your computer.

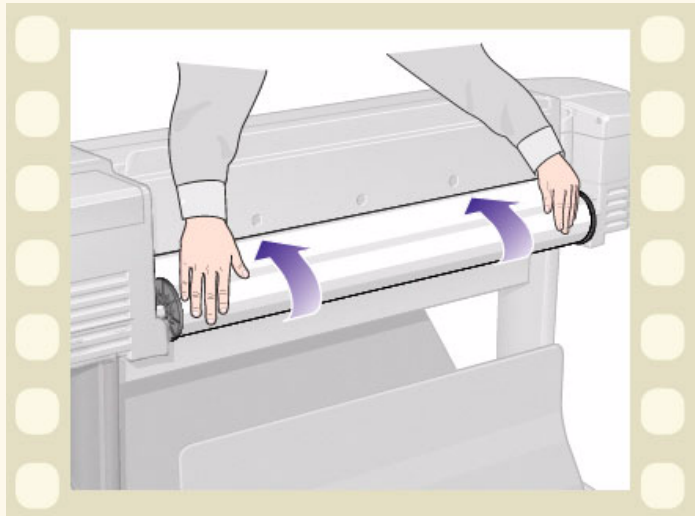

Unloading Roll Media

The animation sequence shows how to unload a roll of paper from the printer.

Click on the  icon to run the animation sequence.

A [printable version](#) of the sequence is also available so that you can take the key illustrations to the printer, if it's remote from your computer.

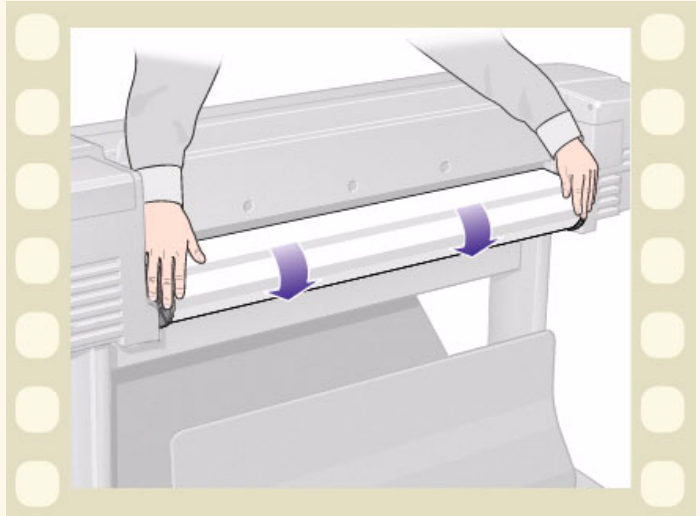

Removing Roll Media from the Printer

The animation sequence shows how to remove a roll of paper from the printer.

NOTE: You must have [unloaded](#) the roll of paper from the printer before you can remove it.

Click on the  icon to run the animation sequence.

A [printable version](#) of the sequence is also available so that you can take the key illustrations to the printer, if it's remote from your computer.

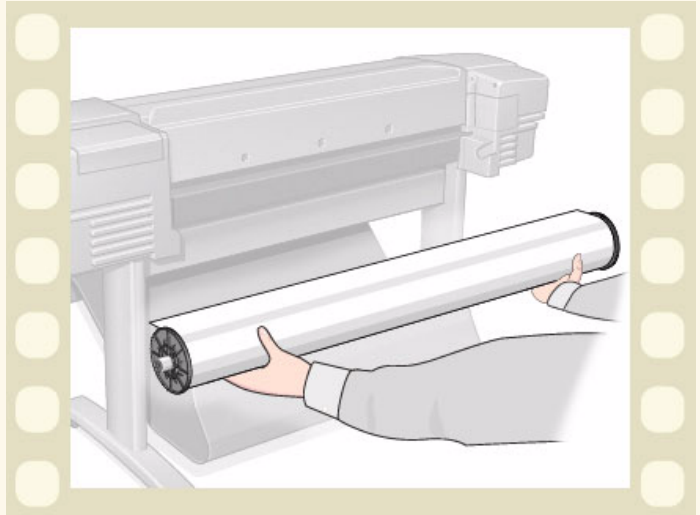

Removing Roll Media from the Spindle

The animation sequence shows how to remove a roll of paper from the roll [spindle](#).

NOTE: You must have [removed](#) the roll of paper from the printer before you can remove it from the spindle.

Click on the  icon to run the animation sequence.

A [printable version](#) of the sequence is also available so that you can take the key illustrations to the printer, if it's remote from your computer.

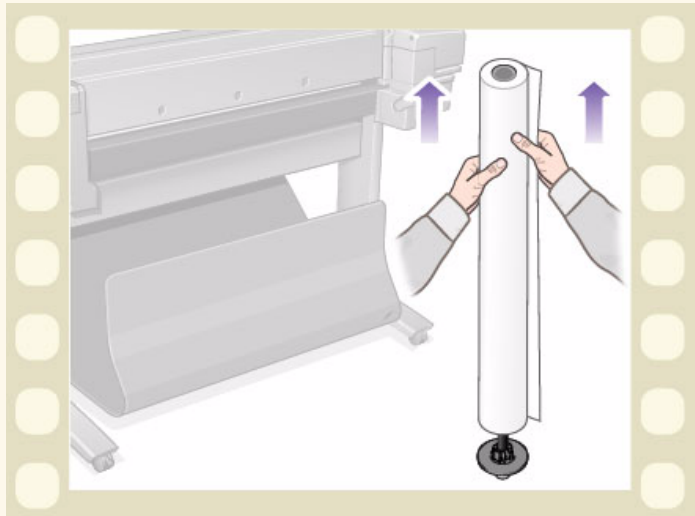

Cutter Replacement

The animation sequence shows the complete procedure for the replacement of the paper cutter in your printer.

Prerequisites

Before attempting to replace the cutter you must contact your local [HP Customer Care](#) center to:

- Order the replacement cutter.
- Receive instructions on how to access the Front Panel Service Menu.

Important Information

- The cutter unit is attached to the printer by a black cutter holder that runs along the metal guide rail, and is hooked onto the edge of the [platen](#) at the front of the printer.
- The cutting wheel is inside the cutter unit.
- Do not remove the cutter holder.
- When inserting the new cutter, with the cutter holder raised to about 45 degrees, partially insert the cutter so it rests in the cutter holder, but do **NOT** clip it in at this stage.

CAUTION: Be very careful when replacing the cutter because you can easily break the cutter holder if you apply too much force.

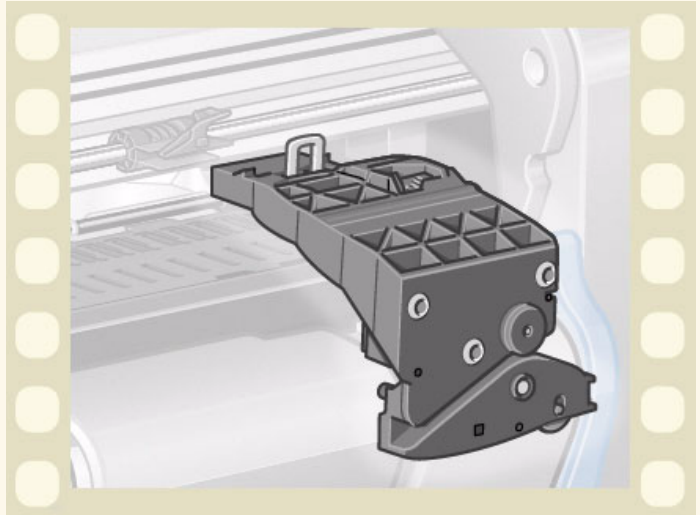

Click on the  icon to run the animation sequence. A [printable version](#) of the sequence is also available so that you can take the key illustrations to the printer, if it's remote from your computer.



Sheet Media

- [Which Side Up](#)
Instructs you how to identify which side of the sheet media should be printed on.
- [Which Edge First](#)
Explains which edge of the sheet should be loaded first (short edge or long edge).
- [Loading Sheet Media](#)
Details the sheet media loading procedure.
- [Unloading Sheet Media](#)
Details the sheet media unloading procedure.



Which Side Up

The printer prints on the side of the paper facing up. It can be important to load the sheet with the correct side facing up. See the table below.

Print Side for Media Types

Media Type	Matte or Glossy
HP Bright White Inkjet Paper (Bond)	Both sides are the same. If sheet is curled, load with curl down.
HP Vellum	
Natural Tracing Paper	
Coated Paper	Load with the coated side up.
Heavy Coated Paper	
Matte Film	Load with the matte side up.
High-Gloss Photo	Load with the glossy side up.
Clear Film	
Translucent Bond	Both sides are the same. If sheet is curled, load with curl down.
Canvas	
Poster Paper	
Plain Paper	Both sides are the same. If sheet is curled, load with curl down.



Which Edge First

You can load sheet paper in either portrait or landscape orientation. Unless you are using the Rotate option, always load the sheet in the same orientation as you have specified in your software.

If you are printing a PostScript file, always load the sheet with the short edge first, even if the width of your image is greater than its length.

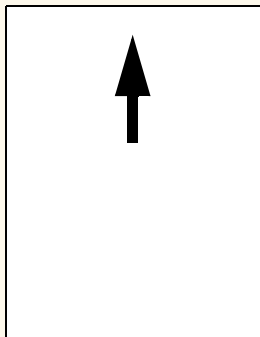

Portrait (Short edge first)
- always use for PostScript
Files

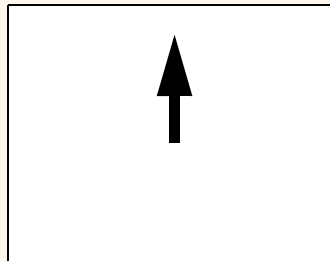

Landscape (Long edge first)



Loading Sheet Media

The animation sequence shows how to load a new sheet of paper on the printer.

Important

- If you have a roll of paper loaded on the printer you must first [unload](#) it from the printer.
- Make sure the [correct side](#) of the sheet is facing up when you load it.

The front panel menu selections are:

Select (using the  keys) Then Press:

- | | |
|-----------------------------|-------|
| 1. Paper | Enter |
| 2. Load sheet | Enter |
| 3. Select Sheet Type | Enter |



Click on the  icon to run the animation sequence.

A [printable version](#) of the sequence is also available so that you can take the key illustrations to the printer, if it's remote from your computer.



Unloading Sheet Media

The animation sequence shows how to unload a sheet of paper from the printer.

Important

- To give the ink [time to dry](#) the printer holds the paper for some time.

Click on the  icon to run the animation sequence.

A [printable version](#) of the sequence is also available so that you can take the key illustrations to the printer, if it's remote from your computer.



Ink System

These topics cover the various elements of the Ink System.

- [What are HP Ink Supplies?](#)
Details the elements of the HP Ink Supplies supplies.
- [Component identification](#)
Shows you where to find the various elements of the Ink System.
- [Ink Supply Guidelines](#)
Explains how to obtain the best results from your Ink System
- [Precautions](#)
Details the specific precautions you must take to avoid damaging the components of your Ink System.
- [Color Calibration](#)
Explains how to calibrate the ink system for the type of media loaded
- [When to Replace](#)
Details on the expected life of your Ink System components.
- [Drying Time](#)
Explains drying time function and details how to use it to ensure you obtain the highest quality print under all conditions.



What are HP Ink Supplies?

For each of the four ink colors used in the printer, there are two separate components, the [printhead](#) and the [ink cartridge](#). These components are called the HP Ink Supplies and are coded with an Hewlett-Packard No. selection number to help you reorder the correct replacement. Your **HP DesignJet 800PS** printer uses the following HP Ink Supplies:

- Black Ink Cartridges are HP No 10 Supplies.
- Cyan, Magenta and Yellow Cartridges are HP No 82 Supplies.
- All Printheads are HP No 11 Supplies.

Ink Cartridges

The Hewlett-Packard ink cartridges for your printer require no maintenance or cleaning. As long as each ink cartridge is inserted correctly into its slot, the ink will flow to the printheads. Because the printheads control the amount of ink transferred to the page, you will continue to see high-quality printing results, even when the ink levels are getting low.

The front panel notifies you when an ink cartridge's ink level is low. You can also check the ink levels of all the ink cartridges to determine if an ink cartridge needs to be replaced, see [Ink Cartridge Information](#).

If the ink cartridge is empty, the printer stops printing. See [Ink Cartridge Replacement](#).

Printheads

The Hewlett-Packard printheads are extremely durable and do not need to be replaced every time an ink cartridge is replaced. They are independent of the ink cartridges and will continue giving excellent image quality results even if the ink cartridges are low in ink.

If you notice a decline in print quality such as lines or dots missing from text or graphics, see [Stepped Lines](#).



Component identification

The following illustration will help you identify the components of the HP Ink Supplies.

Printheads



The Hewlett-Packard selection number on the ink cartridges and printheads makes it easy for you to find the correct HP Ink Supplies for your printer. Determine the color of the printhead or ink cartridge you need, then make sure you purchase or order the correct Hewlett-Packard printhead or ink cartridge. Each ink cartridge and printhead can be purchased separately from your usual Hewlett-Packard retailer. See [Ordering Accessories](#) and [When to Replace](#) HP Ink Supplies.



Ink Supply Guidelines

For optimum results from your printer and the ink system, always follow these guidelines when handling the HP Ink Supplies:

- Always install the ink cartridges and printheads before the expiry date, which is on the packaging.
- Install ink cartridges and print heads in their color-coded slots.
- Follow the instructions on the front panel during installation.
- Avoid unnecessary removal of the ink cartridges and printheads.
- When turning off your printer always use the power off button on the front panel. The printheads are then parked correctly which prevents them from drying out.
- The ink cartridges should never be removed while the printer is printing. They should only be removed when the printer is ready for you to replace them. The front panel will guide you through the removal and installation procedure. See [When to Replace](#) HP Ink Supplies.

CAUTION: When you first received your printer it was supplied with a set of four setup printheads installed in the printhead carriage. These setup printheads are used for the priming of the tubes in the modular ink delivery system. Do not remove the setup printheads from the carriage without following the procedures in the *Setup Poster*.



Precautions

Handle the HP Ink Supplies with care. In particular the printhead, which is a high precision device and must be handled carefully.

CAUTION: Do not touch, wipe or attempt to clean the printhead [nozzles](#). This can damage the printhead.

- Do not put the printhead down on the nozzles.
- Do not be rough when handling the printheads. Always set them down gently.
- Do not drop the printheads. Proper handling will assure optimum performance throughout the printhead life.
- Do not touch the end of the ink cartridge which is inserted into the printer as there may be a small amount of ink on the connection.
- Avoid storing partially used ink cartridges on their ends.

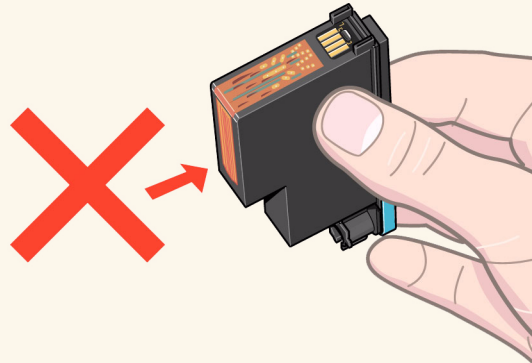

Color Calibration

You can calibrate the ink system for the specific media loaded in your printer. Doing this ensures the printed output matches the colors of the original image as closely as possible. The printer stores the calibration data for each type of media you have calibrated it for since it was powered up. Once the printer has been powered down the next time you use it only the last calibration made will be available and it will print using this calibration data.

To color calibrate your printer, first make sure you have the correct type of media loaded and then make the following front panel selections:

Select (using the  keys)	Then Press:
1. Ink	Enter
2. Color calibration	Enter
3. Calibrate Paper	Enter

The printer prints a calibration pattern and scans it to create the calibration data for the type of media loaded.

If you want to check the color calibration status of your printer, make the following front panel selections:

Select (using the  keys)	Then Press:
1. Ink	Enter
2. Color calibration	Enter
3. Status	Enter

The front panel display shows what types of media the ink system is currently calibrated for.

To remove all the calibrations and reset the printer to its factory values choose *Color calibration > Reset* from the Ink menu.



When to Replace

When to change your HP Ink Supplies is mostly determined by you with guidance from the front panel. This information is provided for:

- [Ink Cartridges](#)
- [Printheads](#)



Drying Time

The following topics detail drying time function and how to use it to ensure you obtain the highest quality print under all conditions.

- [Drying Time Settings](#)
Describes how to set the required drying times from the Front Panel.
- [Typical Drying Times](#)
Lists typical drying times for Hewlett Packard tested paper at approximately 25°C with 50% relative humidity.
- [Drying Procedure](#)
Details how the drying procedure operates.



Drying Time Settings

With some paper types and environmental conditions the ink needs time to dry before the paper is unloaded. The printer has three settings which you can choose through the front panel. See [Navigation Example](#) for more help.

Manual

The printer holds paper which has a specific drying in place and displays a “drying time to go” countdown on the front panel. You can change this time from one minute to 99 minutes in one minute increments.

Automatic

The printer automatically determines the appropriate drying time, based on the type of paper you have selected and the current temperature. If there is any drying time the printer displays a “drying time to go” countdown on the front panel.

None

With this setting, when the printer has finished printing an image the paper will fall into the paper bin under the printer.

CAUTION: Changing the drying time to speed up the printer could result in damage to your printed image or reduce the quality of your print.



Typical Drying Times

The following table shows the typical drying times for Hewlett Packard tested paper at approximately 25°C with 50% relative humidity.

Drying Times by Paper Types

Hewlett Packard Tested Paper Type	Drying Time (seconds)		
	Fast	Normal	Best
HP Bright White Inkjet Paper (Bond)	0	25	
HP Vellum	60	120	180
HP Natural Tracing Paper			
HP Coated Paper	0	60	
HP Heavyweight Coated Paper	0	60	
HP Matte film	60	180	
HP High-Gloss Photo Paper	120		
HP Semi-Gloss Photo Paper			
HP Paper-Based Semi-Gloss			
HP Clear film	60		
HP Translucent bond	60	120	180
HP Studio Canvas	6000		
HP Satin Poster Paper	60		
HP Banners with Tyvek®			
HP Colorfast Adhesive Vinyl			



Drying Procedure

The drying procedure operates as follows:

1. The printed image emerges from beneath the printer window and a vacuum holds it on the [platen](#) of the printer.
2. The front panel displays:

The countdown timer indicates how much drying time remains



3. You can press the Cancel or the Form Feed & Cut key to cancel the drying time and release the paper.
4. After the drying time has elapsed:
For roll media the printer cuts the media and turns off the vacuum so the printed image can drop into the printer bin.
For sheet media the vacuum is turned off and the printed image drops into the printer bin.



Ink Cartridges

- [Ink Cartridges Errors](#)
Details the different error messages that could be displayed on the front panel for the Ink Cartridges.
- [Ink Cartridges Levels](#)
Details the different levels information that can be displayed on the front panel for the Ink Cartridges.
- [Ink Cartridge Information](#)
Shows you how to display the current status of the Ink Cartridges on the Front Panel display.
- [Ink Cartridge Replacement](#)
Details the Ink Cartridge replacement procedure.



Ink Cartridges Errors

Front Panel can display the following error messages for the ink cartridges:

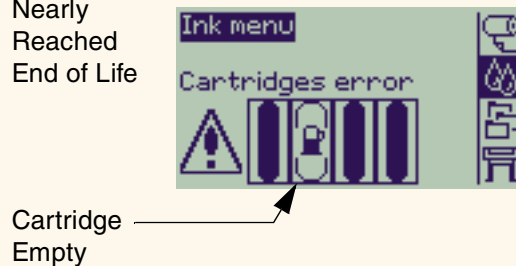
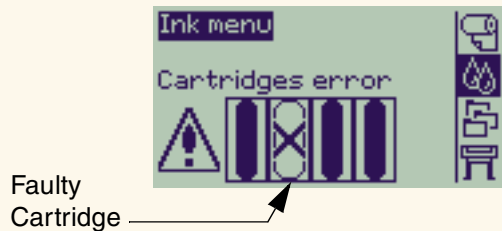
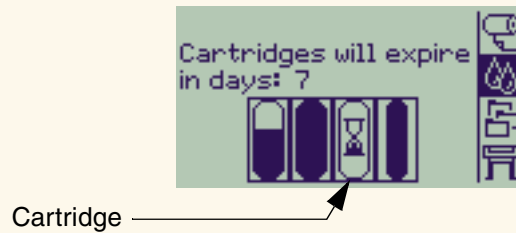
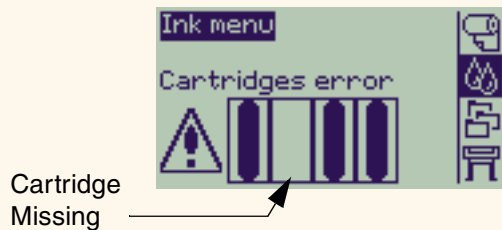

NOTE: If a cartridge has actually passed its expire date it will be shown as a faulty cartridge and will have to be replaced.

The printer will also display the [Ink Cartridges Levels](#).



Ink Cartridges Levels

Front Panel will tell you when your ink supply is low, very low or empty. This means you know current status of your HP Ink Supplies all the time:



Cartridge
Full



Low Ink
Warning



Cartridge
Empty

NOTE: Depending on type of print jobs, a cartridge with a Low Ink Warning may in fact last quite a long time (i.e. line drawings).

NOTE: The Ink Cartridges levels information can also be selected with Ink menu > Information > Ink Cartridges > Ink Levels if it is not automatically shown in the Ink menu.

Ink Cartridge Information

Use the following procedure to display the Ink Cartridge Information screen on the front panel.

The front-panel menu items are:

Select (using the  keys)	Then Press:
1. Ink	Enter
2. Information	Enter
3. Ink Cartridges	Enter
4. Cyan, Magenta, Yellow or Black Ink cartridge	Enter

The front panel displays the following information for the selected ink cartridge:

- Color: Cyan, Magenta, Yellow or Black.
- Model: Hewlett-Packard No 82 (Cyan, Magenta & Yellow) or Hewlett-Packard No 10 (Black).
- Status: inserted, low on ink, out of ink, missing, expired and faulty.
- Expiration date.
- Serial Number.
- Ink Level: in cc and % used.



Ink Cartridge Replacement

The animation sequence opposite shows how to replace an Ink Cartridge.

WARNING: Make sure the printer wheels are locked (the brake lever is pressed down) to prevent the printer from moving.

CAUTION: Only remove an ink cartridge if you are replacing it.

CAUTION: Do not replace cartridges while the printer is printing because doing this will cancel the current print job.

You would need to change cartridges either if prompted to do so on the Front Panel because the printer has detected a cartridge is out of ink or the cartridge is low and you want to replace it before it runs out.

Click on the  icon to run the animation sequence.

A [printable version](#) of the sequence is also available so that you can take the key illustrations to the printer, if it's remote from your computer.



Printheads

- [Printhead Errors](#)
Details the different error messages that could be displayed on the front panel for the Printheads.
- [Printhead Information](#)
Shows you how to display the current status of the Printheads on the Front Panel display.
- [Printhead Replacement](#)
Details the Printhead Replacement procedure.
- [Printhead Alignment](#)
Details the Printhead Alignment procedure.





Printhead Errors

Front Panel can display the following error messages for the printheads:

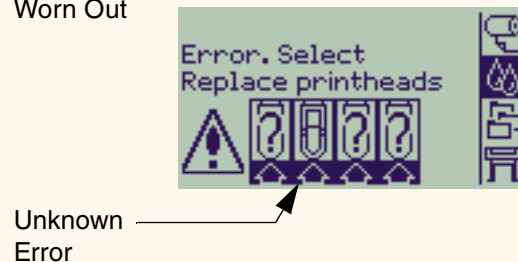
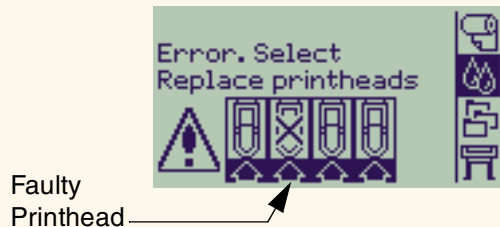
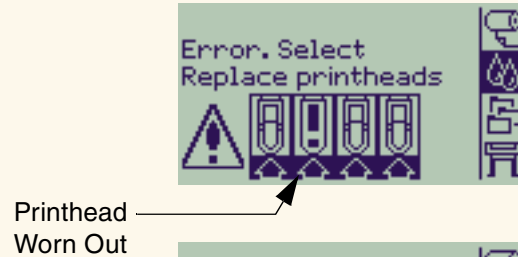
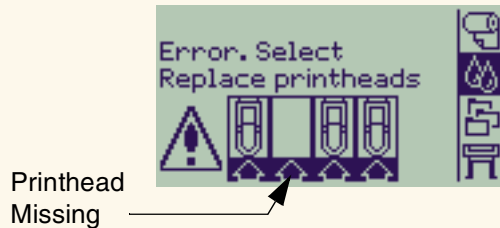
**NOTE:**

An unknown error is displayed when one of the printheads is causing a problem but the system cannot detect which one it is. Refer to [Unknown Printhead Error](#) to solve this problem.



Printhead Information

Use the following procedure to display the Printheads Information screen on the front panel.

The front panel menu selections are:

	Select (using the  keys)	Then Press:
1.	Ink	Enter
2.	Information	Enter
3.	Printhead	Enter
4.	Cyan, Magenta, Yellow or Black printhead	Enter

The front panel displays the following information for the selected printhead:

- Color: Cyan, Magenta, Yellow or Black
- Model: Hewlett-Packard No 11 and Warranty (In warranty or out of warranty)
- Status: inserted, missing, faulty worn-out and unknown.

If there is a problem the system displays an action: missing -> insert, unknown -> troubleshoot, faulty, worn out -> replace.

- Expiration date.
- Serial Number.
 - Ink Used: in cc and % used.
 - Paper Jams.
 - If the printheads are aligned and color calibrated.



Printhead Replacement

The animation sequence shows how to replace a printhead in the printer.

The front panel menu selections are:

Select (using the  keys)

Then Press:

- | | |
|------------------------------|-------|
| 1. Ink | Enter |
| 2. Replace Printheads | Enter |

Click on the  icon to run the animation sequence.

A [printable version](#) of the sequence is also available.

Once you have replaced the printhead, if you have media loaded, the printer prompts you to start the [Printhead Alignment](#) procedure. If no media is loaded the printer prompts you to load paper and then automatically starts the alignment. The alignment takes several minutes to complete and then printer will then prompts you to run the [Color Calibration](#) procedure.

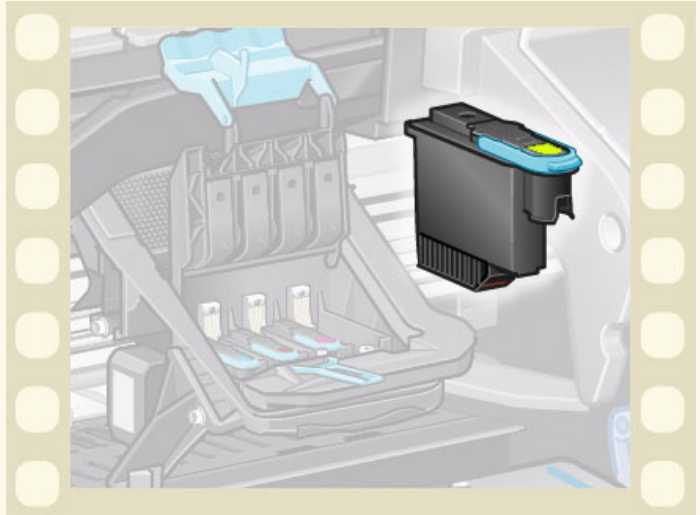



Printhead Alignment

You should have one of the following types of paper loaded before attempting to align the printheads: HP Bright White Inkjet Paper (Bond), HP Coated Paper, HP Heavyweight Coated Paper, HP High-Gloss Photo Paper, HP Satin Poster Paper or Plain Paper. If you try to do this with any other type of paper loaded the printer will prompt you to load a different type of paper before letting you align the printheads.

From time to time you may be required to align the printheads to ensure maximum print quality. To manually select the printhead alignment make sure you have the correct type of roll or sheet media loaded.

There are two types of alignment, Standard which will take about 4½ minutes, or Special which takes about 11 minutes. Standard alignment is recommended for normal use and requires paper of at least A4/Letter-size, loaded in landscape mode. Special alignment should be used to correct pen to paper spacing variations which would be show by variations in vertical line quality, particularly in wide plots and fast print modes. Special alignment requires paper of at least A3/B-size, loaded in landscape mode. Two separate prints are made.

Then use the following front panel menu selections to start the alignment:

Select (using the  keys)	Then Press:
1. Ink	Enter
2. Align Printheads	Enter
3. Standard (4.5 minutes) Special (11 minutes)	Enter

Once you have made this selection the printer starts the alignment process which then takes several minutes.

The printer will also automatically use the standard alignment process to align its printheads after [Printhead Replacement](#). When the alignment procedure completes after a printhead replacement the printer prompts you to ask if you want to run the [Color Calibration](#) procedure.



Solutions

These topics guide you through the different procedures required to troubleshoot and find the solution to various problems you could encounter while using your printer.

The Solutions Tab contains these topics:

- [Solving Problems](#) aids you to quickly troubleshoot your specific problem, it also contains instructions on where you get further information.
- [Image Quality Problems](#) helps you to solve any image quality problems you may be experiencing. It takes you through the troubleshooting procedure step-by-step.
- [Ink Supply Problems](#) guides you when you have problems installing the ink consumable items, the ink cartridge and printhead.
- [Media Problems](#) contains information on what to do if you have image smears or marks on your media and also what to do if you have a media jam.
- [Image Error](#) contains information on what to do if the image that your printer printed is incorrect, or not what you expected.
- [Other Problems](#) covers miscellaneous problems you could face.
- [Getting Help](#) explains what to do if you cannot solve the problem you are having. It also provides full details of the steps to take to contact the Hewlett Packard Customer Care Center.



Solving Problems

- To find the meaning of front-panel messages, see [Message Descriptions](#).
- If you know the problem is related to a certain task, first check the relevant section in this manual, for step-by-step procedures. Use this manual's index or table of contents to find the section. For example, if you are having difficulty with page formatting, refer to [Page Format](#).
- If the problem is directly related to the quality of your printed images, refer first to [Image Quality Problems](#).
- Refer to the appropriate topic:
 - [Ink Supply Problems](#)
 - [Media Problems](#)
 - [Communication Problems](#)
 - [Image Error](#)
 - [Other Problems](#)
- If the problem could be related to your software driver, and you are using an HP driver, refer to the driver's troubleshooting documentation and the on-line help in your application software.
- If the problem has no obvious cause, refer to [Finding the Source of Your Problem](#).
- If you still cannot solve the problem, see [Getting Help](#).



Finding the Source of Your Problem

1. Look at the front-panel display for messages. See [Message Descriptions](#) for a full explanation of front-panel messages.
2. Test the printer.
 - Switch the printer off on the front of the printer. Make sure that the power cord is firmly inserted in the printer and plugged in to an outlet that you know works.
 - Switch the printer on and make sure the front-panel display shows the HP welcome screen followed by Main Menu after a short initialization period.
3. Test your computer hardware and interface.
 - Make sure that you have the correct interface cable between the computer and the printer and that it is firmly connected to the correct ports (see the *Setup Poster*).
 - Check that your printer's [graphics language](#) setting (in Setup > Graphic Language) matches the requirements of your software.



Image Quality Problems

Your **HP DesignJet 800PS** printer provides a full troubleshooting utility to ensure you can always quickly overcome any image problems you encounter. You should use this utility whenever you (and not the printer) perceive a problem with print quality.

Often what you believe to be a print quality problem is in fact caused by incorrect configuration of the printer for the type of image you are trying to print. Always check [Configuration Correction](#) as your first diagnostic task to find the cause of your problem.

If a message, such as “PRINTHEADS not functional” appears on the front-panel of your printer, follow the instructions given for the particular message (see [Message Descriptions](#)).

The types of problems you could possibly encounter are:

- [Stepped Lines](#)
- [Incomplete Lines](#)
- [Color Accuracy](#)
- [Horizontal Banding](#)
- [Color Alignment](#)

Whenever you see any of these problems work through the [Troubleshooting Procedure](#) replying to the questions displayed on the front-panel. This will lead you to correct remedial action required to solve your image quality problem.



Configuration Correction

Before attempting the image quality diagnostic procedures contained in this section it is important to first check that the printer is correctly configured to print what you want. Many problems concerned with image quality can be solved by correcting the way the printer is configured.

1. To achieve the best performance from your printer, only use **genuine** HP accessories and supplies, whose reliability and performance have been thoroughly tested to give trouble-free performance and best-quality prints. For details of HP media, see [Paper Types](#).
2. Make sure that the **Type of paper** selected in the front panel is the same type of paper loaded into the printer. To check this go to the Roll or Sheet menu in the front panel and press **Enter**.
3. To ensure the maximum print quality use **HP certified media** only. For details of HP media see [Physical Characteristics of Paper Types](#). You can also look at the web page <http://www.hp.com/go/designJet> for the most up to date information.
4. Make sure that the **Print quality** (Fast, Normal, Best) used for your printer is correct. This is set in the Print Setup dialog box of the printer driver or in the front panel from the Set-up menu. The printer driver setting overrides the front panel setting.
5. Select **Best** print mode for maximum print quality.
6. For **Non-HP drivers**, set front panel media settings to match the media type loaded in the printer. The documentation that came with your software should provide information about media type/print quality settings.
7. If your image quality problem is color accuracy related, go to [Color Accuracy](#) for further configuration help.



Troubleshooting Procedure

Working through the Troubleshooting procedure should always be your first action when you encounter image quality problems. Refer to the [Troubleshooting Flow Chart](#) for a description of the sequence of processes used to complete troubleshooting procedure.

It is important that the paper loaded for this procedure is exactly that used when you encountered image quality problems, type (for example, glossy paper) . If you use a different kind of paper or a different size, you stand less likelihood of resolving the problem.

Running the Troubleshooting Utility

1. From the main front-panel menu, select the **Ink menu** () and press **Enter**.
2. Select **Troubleshooting** and press **Enter**.
3. The printer first checks to see whether the printheads are aligned. Misalignment of the printheads is a common cause of image quality problems. If they are not aligned, you are prompted to accept the [Printhead Alignment](#). This procedure requires a few centimeters of paper loaded and takes several minutes to perform.

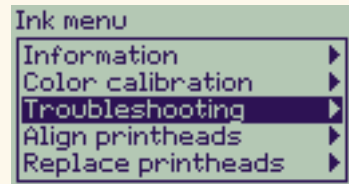

NOTE: Note that you do not have to interpret the patterns printed by the Printhead Alignment routine.

4. If the printheads do not seem to require alignment, the printer prints **Diagnostic Print A**. See [Diagnostic Print A Interpretation](#) for full details of how to use this diagnostic print.



Diagnostic Print A Interpretation

Diagnostic Print A contains several blocks of color and a block of thin black broken lines (the lines are actually very much closer than those represented here).

1. Examine the broken lines in Diagnostic Print A carefully and indicate whether there are problems with them.

The sorts of problems to look for here are:

- Jaggedness or serrations in the thin lines, like this:

; the thin lines should be straight, though not necessarily perfectly aligned. The irregularities that are significant extend along the whole of the length of the lines. Shorter irregularities, arranged in columns, can be ignored at this stage.

2. Examine the blocks of color in Diagnostic Print A carefully and indicate whether there are problems with them. The sorts of problems to look for here are:

- White streaks or bands in the solid blocks.

3. If you indicate that there is a problem with the dashed lines in Diagnostic Print A, you are prompted to use the [Advance Calibration](#) routine; your printer will be at step 3 of the routine (if you don't want to continue with calibration, press the **Cancel** key).

4. If there are problems in the blocks of color in Diagnostic Print A, for example white streaks or bands, the printer will try to clean the printheads that have the problem. A printhead can be cleaned up to three times this way; after that it cannot be cleaned and you will be told; the **Troubleshooting** routine will finish. In that case we recommend that you try to reprint your print, and then, if necessary, start the **Troubleshooting** routine again. After cleaning the printheads, the printer reprints the blocks of color (but not the black lines) in Diagnostic Print A, and asks you to examine it again (as in step 1).

5. If there are no problems the first time you print Diagnostic Print A, the printer prints **Diagnostic Print B**. See [Diagnostic Print B Interpretation](#) for full details of how to use this diagnostic print.

Diagnostic Print A

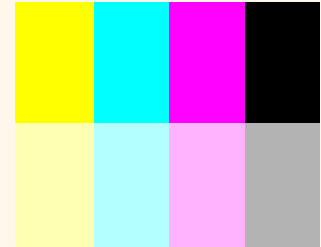

Ignore this
black bar →

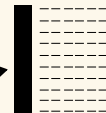

Diagnostic Print B Interpretation

- For each color in the pattern in **Diagnostic Print B**, you are asked about the quality—look for missing lines. If you answer that a color is defective, the printer tries to clean that printhead. If the printhead cleaning process completes, **Diagnostic Print B** is printed again and you are asked the same questions again.
- Afterwards, if problems with images remain, use the **Troubleshooting** procedure again.

If none of the patterns or blocks in the two **Diagnostic Prints** shows any problem, it could be that your image quality problem is caused by a wrong setting in your software, or perhaps the job should have been printed with the **Print quality** set to **Best** instead of **Normal** or **Draft**.

If the **Troubleshooting** routine didn't indicate that printhead alignment was necessary, you can select **Align printheads** in the Ink menu to try to solve any further image quality problems.

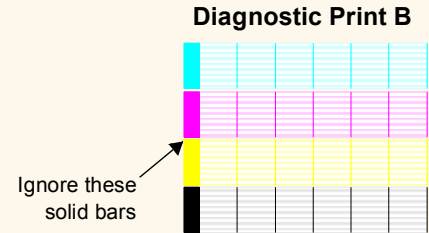

Advance Calibration

It is important that the paper loaded for this calibration is exactly that used for normal printing, both in quality (for example, glossy paper) and in width (for example, A0 or 36-inch). Either roll or sheet paper can be used.

The routine prints a pattern and then cuts the roll (the cutter must be set to ON - see [Controlling the Cutter](#)) or ejects the sheet; it requires paper that is at least 65 cm/25.5 inches long and at least 50 cm/19.7 inches wide. You must then reload that piece of paper *as a sheet*, so that the printer can accurately measure the pattern, and make whatever adjustments are appropriate to the amount it advances between printing swaths of data. (See [Loading Sheet Media](#))

The pattern printed is solely for the use of the printer; you are not expected to relate any of its characteristics to the quality of your images.

1. From the main front-panel menu, with the correct paper loaded, select the **Paper** menu () and press **Enter**.
2. Select **Advance calibration** and press **Enter**.
3. Select **Create pattern** and press **Enter**.
The printer prints its calibration pattern (as represented opposite) and cuts or ejects the paper.
4. Load the sheet printed side up with the dotted line at the top (that is, rotated 90°).
5. Now select **Measure pattern** and press **Enter**.
The printer reads the calibration pattern and makes the appropriate internal adjustments.

These [Advance Calibration Values](#) are used whenever you print on the same type of media until you have used the Advance calibration twice more with different types of media.

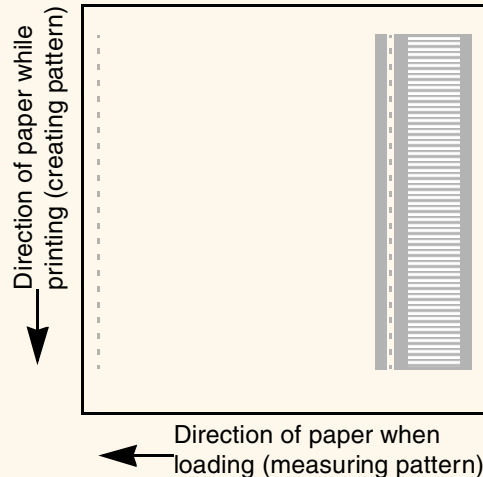

Advance Calibration Values

The printer stores the advance calibration values of the last two different types of media used for the calibration. When you print the printer tries to match the media you have selected to the stored values. If there is a match the printer applies the stored Advance calibration values.

If the type of media you are using has not been used for either of the last two Advance calibrations the printer uses a set default values for your media.

The Restore factory option of the Advance calibration menu erases any stored advance calibration values from the printer memory. This means that until you run the advance calibration again the printer will use the factory default values for all types of media.

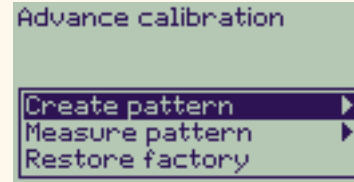

Stepped Lines

When you look at the image you have printed there are ‘**stepped lines**’ in the borders of arrows and diagonal lines. The lines should be straight with no stepping.

The following is an example of what you might see if you have problems with Stepped Lines.

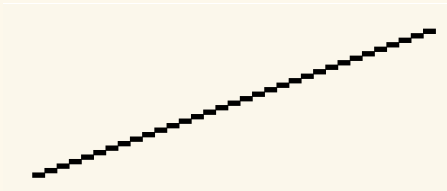

To solve this problem:

1. Increase the dpi setting by changing the print quality to **Best** in the front panel and driver software.
2. The problems may be inherent in the image you are trying to print. Try to improve the image with the **application** that generated the file.



Incomplete Lines

When you look at the image you have printed there are:

- Missing or faint lines
- Printed characters having missing parts to them.

The following is an example of what you might see if you have problems with incomplete lines.



Missing parts of text; this
should say TEST

See the [Troubleshooting Procedure](#) for instructions on how to solve this problem.



Color Alignment

When you look at the image you have printed:

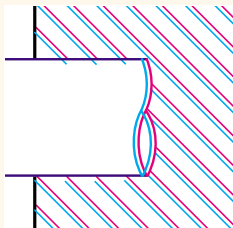

The colored lines are printing double and they are the wrong colors

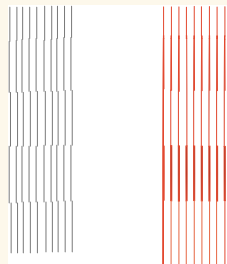

Vertical lines are mis-aligned or fuzzy (not smooth)

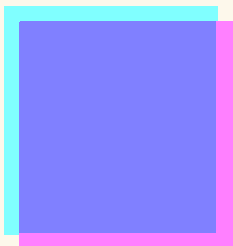

The borders of colored blocks are overlapped and the overlapping areas have different colors in them.

See the [Troubleshooting Procedure](#) for instructions on how to solve this problem.



Horizontal Banding

When you look at the image you have printed there are light or dark lines on the image, these are particularly highlighted in high density ink areas. This problem is known as banding.

IMPORTANT

Banding can occur to a certain degree in Fast and Normal mode when printing high density prints. To obtain the best image always print in Best Mode.

The following is an example of what you might see if you have problems with banding.

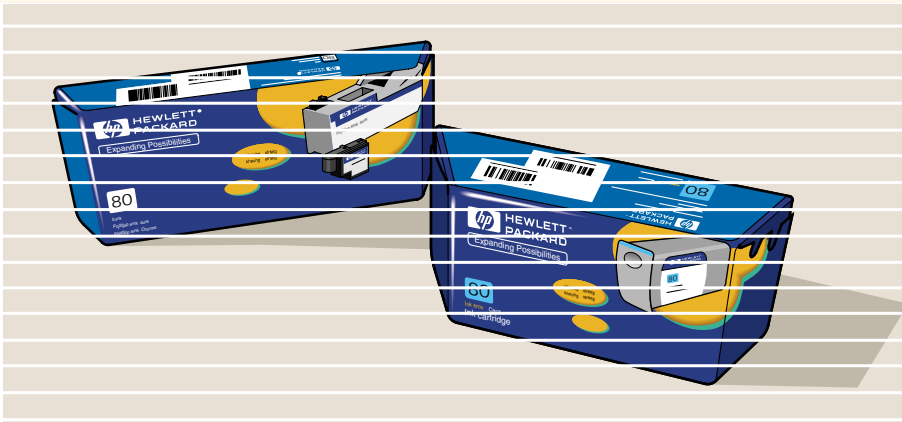

See the [Troubleshooting Procedure](#) for instructions on how to solve this problem.



Color Accuracy

These are the areas you should review when troubleshooting a color accuracy problem:

Configuration

Check that you are using the correct driver setting for your software. Check which ink emulation mode has been selected in the front panel; see [Color Settings](#).

Media

Ensure the media loaded is genuine HP media and the correct media type selected on the front panel and in the driver.

Related Topics

- [Color Consistency problems](#)
- [Long Term Color Bleeding \(Glossy Papers\)](#)
- [Color Accuracy Configuration](#)
- [Additional Color Accuracy Information](#)



Color Consistency problems

- Some media may discolor or change with age. Check that your media is fresh and has been stored correctly.
- If the environmental conditions you are printing in change rapidly, you may see changes in the color consistency. By reducing the time the print stays in extreme environmental conditions after being printed (especially very high humidity) you can reduce the color consistency problems.
- There may be color changes between images printed on your **HP DesignJet 800PS** and other types HP DesignJet printers. This is quite normal because the other printers use different ink.

Long Term Color Bleeding (Glossy Papers)

High ambient humidity at your location could cause the colors to bleed into the paper making the lines fuzzy and bleary.

- Change the paper that you are printing with or remove the printer out the high humidity conditions.



Color Accuracy Configuration

The configurations of the printer defines how ink is applied to each type of media. Use the information in the following table to configure your printer and software for best color accuracy.

Location of Setting	Setting Description	Selection
Ink Menu	Color Calibration > Calibrate Paper	Set to match the media type loaded in the printer. See Paper Types .
Ink Menu	Color settings > CMYK	Set the type of CMYK inks that your software generates. If you use HP drivers use “Native”.



Additional Color Accuracy Information

The means of accurately managing the colors printed by your printer vary with the software application and driver being used. Refer to the following documentation:

- The *Software Application Notes* for your application, in the package shipped with your printer.
- On-line documentation in the drivers shipped with your printer.
- If you cannot find any reason for the discrepancy, before getting help, find out for which CMYK printer inks the colors have been specified.



Ink Supply Problems

Most of the problems that you could encounter when working with the HP Ink Supplies are solved with guidance from the front panel. The only exception to this is the [Unknown Printhead Error](#). A full list of front messages are supplied in [Message Descriptions](#).

Printhead Problems after Replacement

If after replacing the printheads, the printer complains about wrong or missing printheads,, perform the following steps:

- Check that you have removed the protective tape from the printhead.
- Insert the printhead into the carriage assembly but this time close the cover using the latch.
- Replace the printhead with a new one, see [Printhead Replacement](#).

Problems Inserting the Ink Cartridge

1. Make sure that you have the correct HP Ink Supplies ink cartridge.
2. Make sure that the cartridge is the correct color for that slot.
3. Make sure the cartridge is in the correct orientation, with the color coded label at the top.

CAUTION: Never clean inside the ink cartridge slots.

Problems inserting the Printhead

1. Make sure that you have the correct HP Ink Supplies printhead.
2. Make sure that the printhead is the correct color for that slot.
3. Make sure that the printhead is the correct orientation.

See [Printhead Replacement](#) for further details.



Unknown Printhead Error

An unknown printhead error occurs when the one of the printheads is causing a problem but the system cannot detect which one it is. Whenever this happens the front panel displays this error message. The number of printheads with unknown errors will either be all the color printheads or all the printheads.

Use the following procedure to isolate the faulty printhead.

1. Select replace Printheads from the front panel.
2. Open the Carriage cover and remove ALL the Printheads.
3. Reinsert the Cyan Printhead only and close the Carriage cover and the Window.
4. Check the front panel - if the status of the Cyan Printhead is **X** or **?** then the conclusion is that the Cyan Printhead is faulty and must be replaced. If the status of the Cyan Printhead is OK the conclusion is that the Cyan Printhead is working correctly. Repeat the process from **step 1** for the other color Printheads to identify which one is failing.

Printheads not aligned.
Paper type not valid
to align printheads.

Press ENTER to continue



Media Problems

- [Media](#)
Details the general rules to follow to avoid media problems.
- [Clearing a Media Jam](#)
Describes how to clear a media jam.
- [Ink Marks on the Media](#)
Details the way to solve ink mark problems; warped lines, blurred lines, marks or scratches on glossy paper.
- [Media Loading Problems](#)
Explains what to do when the Front Panel keeps indicating that media is misaligned or incorrectly positioned.
- [Media Output Problems](#)
Explains what to do when the prints fall on the floor or do not stack correctly in the media bin.



Media

Always make sure that you are using the appropriate media for your image and that it is consistent with your software application. To ensure color accuracy and print-quality performance of the printer, use only media types that have been certified for your printer.

Use of non-HP media or HP media not certified for your printer may significantly reduce the color and print quality of your images. For details of HP media, see [Paper Types](#).



Clearing a Media Jam

If the front panel displays this message:

There is probably paper jammed in the printer. Paper jams can have various causes:

- The paper is too thick or too thin for the printer, or is otherwise not supported
- The paper is creased or misaligned or is bubbled
- Too much ink is being placed on the paper causing it to cockle or bubble
- The end of the roll of paper is glued to the core and won't advance further
- Pieces of paper or paper powder are clogging up the cutter guide or other moving parts.

See [Removing jammed paper](#) for full instructions on how to clear jammed paper.

Possibly a paper jam

1. Open window
2. Switch power off
3. Clear paper path
4. Switch power on
5. Align printheads



Removing jammed paper

1. Open the window.
2. Switch the printer off at the front.
3. If necessary, carefully move the printhead carriage out of the way—if possible all the way to the enclosed area on the left or the right. Which way you are able to move it depends on where the paper is jammed.

CAUTION: When moving the printhead carriage, touch only the black plastic parts.

4. If necessary, carefully move the paper cutter out of the way to the left, or to the right depending on where the paper is jammed (though if moved right it may block the paper path).

CAUTION: The cutter is easily moved by holding it as close as possible to the guide running across the width of the printer. Be careful not to touch the metal slider bar that runs across the printer.

5. If necessary, lift the blue paper lever, to release any trapped paper. Remember to lower it again when you have finished.
6. Carefully remove any of the jammed paper which you can easily lift up and out from the top of the printer.
7. Carefully pull the rest of the roll or sheet down and out of the printer. You may need to cut the edge of the roll with scissors.
8. Check that the printing zone, including the cutter guide, the paper path, and the area where the printhead carriage is parked, is clear and clean; remove any paper powder by brushing it away or with a vacuum cleaner.

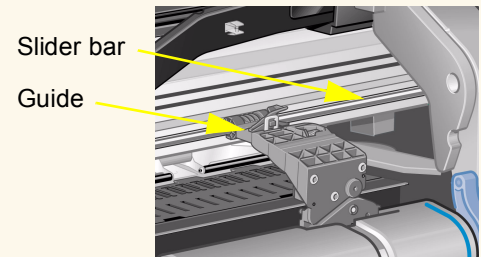

[More ...](#)



Removing jammed paper (Continued)

CAUTION: The area where the printhead carriage is parked can get quite dirty; be careful not to get ink on your hands.

9. Close the window and switch on the printer.
10. Wait for the printer to finish initializing.
11. Press the **Form Feed and Cut** key on the front panel to eject any small pieces of paper that are still in the paper path.
12. Reload the paper as normal (see [Loading Roll Media](#) and [Loading Sheet Media](#)). If you are using roll paper you may need to trim the edge first, to ensure that it is straight.

NOTE: If there is still paper left in the paper path, try loading a sheet of stiff or rigid paper into the printer, such as heavy coated or matte film; this will help to force out any paper jammed in the paper path.

13. If the cutter seems to be causing the problem, check in the *User's Reference Guide* on the *Using Your Printer* CD that the type of paper is supported by the printer. Try disabling the cutter from the front panel; use  → **Cutter** → **Off**.

You are strongly recommended to align the printheads (see [Printhead Alignment](#)) after clearing a paper jam, as the problem may have caused the printheads to be misaligned.



[Back ...](#)



Ink Marks on the Media

- [Warped Lines](#)
- [Blurred Lines \(Ink “Bleeds” from Lines\)](#)
- [Marks or scratches on glossy paper after printing](#)
- [Smears or Scratching on Your Printed Media](#)



Warped Lines

- The media itself may be warped. This can happen if it has been used or not be stored in the environment conditions.
- For all environmental specifications, see [Environmental Specifications](#).

Blurred Lines (Ink “Bleeds” from Lines)

- Perhaps you have adjusted the drying time in the front-panel menu to speed up the printer output. Set “Drying time” to “Automatic”.

For details of drying time adjustments, see [Ink System](#).

Marks or scratches on glossy paper after printing

Glossy paper may be extremely sensitive to the bin or anything that it comes into contact with directly after printing. This will depend on the amount of ink printed and the environmental conditions that are present at the time of printing. Avoid any contact with the paper and handle the print with care until quite some time has elapsed.

NOTE: Included with HP media is a book “*Printer Tips*” that includes a section on troubleshooting paper problems.



Smears or Scratching on Your Printed Media

This problem can appear on paper-based coated media if a lot of ink is printed quickly. The media cannot absorb the ink quickly enough and becomes distorted. As the printheads move over the media, the printheads and the media come into contact with each other and the printed image is smeared.

1. Press the **Cancel** key on the front panel; if you continue to print, the paper may damage the printheads.
2. Cancel the print job from your computer application.
3. In order to obtain better results perform the following:
 - Use HP recommended media. If the image you are printing has intense color, use HP Heavy Coated Paper.
 - Try to increase the print margins by relocating the image in the page from your software applications.
 - If you are using 'Media Saving Options' from the advanced section of the HP- GL/2 Driver, try disabling one or both the options 'Auto Rotate' and 'Inked Area'.

If the above fails to solve the problem of smears and scratching, change the media you are using to a non-paper based media such as HP Clear film.



Media Loading Problems

The Front Panel Keeps Indicating that media is misaligned or incorrectly positioned.

Roll media

- The roll media may be loaded the wrong way. The paper should load over the roll towards you, see [Loading Roll Media](#).
- The paper may be skewed. The right-hand edge must be parallel to the blue line on the front media deflector.
- Ensure that the paper is wrapped tightly on the roll.
- Check that the paper is correctly loaded onto the spindle, see [Installing a New Roll on the Printer](#).

Sheet media

- The sheet media must be loaded with the right-hand edge against the blue line on the printer platen and the front edge against the blue line just after the pinch rollers, see [Loading Sheet Media](#).
- The media may be crumpled or warped or may have irregular edges.
- If you are using hand-cut media, the edges may not form a right-angle or they may be rough. Do not use hand-cut media. Use only purchased sheet media.
- If the media is curled with the curl up it will be very difficult to load. It is easier to load it with the curl down



Media Output Problems

Prints Fall on the Floor After Being Cut

- Make sure the media bin is open.
- Do not let more than twenty prints accumulate in the bin.
- Make sure roll media is loaded correctly. If the paper is loaded incorrectly, the natural curl of the media may cause it to miss the bin and fall to the floor.

Prints Do Not Stack Properly in the Media Bin

- The printer may be too close to the end of the roll. The natural curl near the end of the roll can cause stacking problems. Load a new roll or remove prints manually as they are completed.
- If you are mixing prints or nesting sets of several different sizes, you may have stacking problems because of the different sizes of media in the bin.



Image Error

- [Image is Incomplete](#)
Details the actions to take when the print is: Blank, Partial or has suffered [clipping](#).
- [Printed Image Incorrect](#)
Explains why the image is:
 - In one portion of the printing area
 - Unexpectedly rotated.
 - Mirrored.
 - Distorted or unintelligible.
 - Overlaid with another image.
 - Does not obey page format and rotate commands.
- [Other Sources of Information](#)
Lists others sources of information for image problems.



Image is Incomplete

- [Print is Completely Blank](#)
- [Output Contains Only a Partial Print](#)
- [Image is Clipped](#)
- [Long-Axis Print Is Clipped](#)



Print is Completely Blank

If the front-panel Graphics language setting is Automatic (the default), try the other settings: (PostScript for a PostScript file, HP-GL/2 for an HP-GL/2 file, etc., and send the file again.

Output Contains Only a Partial Print

- Did you press **Cancel** or **Form Feed and Cut** before all the data was received by the printer? If so, you have ended the data transmission and will have to print the page again (you normally don't need to press Form Feed and Cut to unload the print).
- The **I/O Setup > I/O Timeout** setting may be too short. From the front-panel menu you can increase the I/O Timeout setting to a longer period and then send the print again.
- There may be a communications problem between your computer and the printer. Check your interface cable.
- Check to make sure that your software settings are correct for your current page size (e.g., long-axis prints).



Image is Clipped

- This normally indicates a discrepancy between the actual printing area on the loaded media and the printing area as understood by your software. For general advice on printing areas and page size, see [Printable Area](#).
- Check the actual printing area for the media size you have loaded (printing area = media size minus margins). For media size and margins, see [Printable Area](#).
- Check what your software understands to be the printing area (which it may call “printable area” or “imaggable area”). For example, some software applications assume standard printing areas that are larger than those used in this printer.
- Check that the orientation of the media is the same as that assumed by your software. The front-panel **Paper > Page format > Rotate** option changes the orientation of a print and, on roll media, the orientation of the page. It is possible that a rotated image on roll media may be slightly clipped in order to retain the correct page size, as explained in [Page Size](#).
- You may have asked to rotate the page from portrait to landscape on media that is not wide enough, for example a D/A1-size page rotated on a D/A1-size roll.
- If necessary, change the printing area in your software.
- The file may be too large for the printer’s memory.

Long-Axis Print Is Clipped

- Does your software support long-axis prints?
- Have you specified an appropriate media size in your software?
- Make sure that the printer’s **Page format > Size** is set to **Inked area**.
 - There may not be sufficient memory.



Printed Image Incorrect

- [Image is in One Portion of the Printing Area](#)
- [Image is Unexpectedly Rotated](#)
- [Print is a Mirror Image of the Original](#)
- [Print is Distorted or Unintelligible](#)
- [One Image Overlays Another on the Same Sheet](#)
- [Pen Settings Seem to have No Effect](#)
- [Page Format or Rotate does not Work](#)



Image is in One Portion of the Printing Area

- Is the page size configured in the software too small?
- Are you sure that your software doesn't believe the image to be in one quadrant of the page?
- Otherwise, this indicates an incompatibility between the software and the printer:
- Is your software configured for this printer? For general advice, see the **Setup Poster**. For advice specific to your software, see either the documentation supplied with the driver.
- If you still haven't found the solution, try changing the printer's Graphics Language setting on the front panel (**Setup > Graphic Language**).

Image is Unexpectedly Rotated

- Check the front-panel **Paper > Page format > Rotate** setting.
- If Queueing and Nesting are both ON, pages may be automatically rotated to save media. See [Rotating an Image](#)

Print is a Mirror Image of the Original

- Check the front-panel **Paper > Page format > Mirror** setting.



Print is Distorted or Unintelligible

- The interface cable between your computer and the printer could be faulty. Try another cable to see if the problem is corrected.
- If you have connected your computer to the parallel port on the printer, make sure you are using a genuine HP parallel interface cable.
- Depending on the software, drivers and RIPs you are using with your printer, there will be different solutions to solving this problem. Refer to the Vendor's User Documentation for details.

One Image Overlays Another on the Same Sheet

- The I/O Setup / I/O Timeout setting may be too long. From the front-panel menu decrease the setting and print again.

Pen Settings Seem to have No Effect

- Either: you have changed them in Pen settings / Define palette but forgotten to select that palette in Pen settings / Palette,
- Or: you expected the software-driven pen settings but in the front-panel Pen settings / Palette is not set to Software.
- Or: you changed the setting in the front panel but this has been ignored by the printer because the driver setting has not been changed.

Page Format or Rotate does not Work

- The printer cannot rotate [raster](#) images. If your file contains raster data (typically, images with heavy area fill and shading that you have scanned into your software) you will not be able to rotate the print.
 - Your driver does not allow this to happen.



Other Sources of Information

If you don't find the solution to the problem here, other sources of help are:

- The documentation supplied with the driver that you are using to manage the output from your software application to the printer.

For example, the on-line and printed documentation included in the following drivers supplied with your printer:

- HP DesignJet PostScript® drivers for Power Macintosh® and Macintosh® (QuickDraw™)
- HP DesignJet PostScript® drivers for Microsoft® Windows™ applications.
- AutoCAD™ windows drivers
- Windows drivers
- The HP-GL/2 driver documentation supplied with your application software.



Other Problems

- [Communication Problems](#)
Describes typical problems you could encounter with communications between your computer and the printer.
- [Printer does not Print](#)
Details common causes for the printer failing to print.
- [Printer Seems Too Slow](#)
Lists the reasons why printing may slow down.
- [Printer Waits Too Long to Print a Nest](#)
Explains the cause for the printer waiting too long to print a nest.



Communication Problems

Symptoms are:

- The front-panel display does not show **Processing** when you are sending a print to the printer.
- Your computer displays an error message when you are trying to print.
- Your computer or printer “hangs” (stays idle) while communication is taking place. However, note that large prints can take a correspondingly long time to print.
- Your printed output shows random or inexplicable errors (misplaced lines, partial graphics etc.)

How to solve the problem:

- Have you selected the correct printer in your software?
- Does the printer work correctly when printing from other software?
- If the printer is connected to a network, try using it when connected directly to your computer through parallel or USB ports.
- If your printer is connected to your computer through any other intermediate devices, such as switch boxes, buffer boxes, cable adapters, cable converters etc., try using it when connected directly to your computer.
- Try another interface cable. For details of supported cables, see [Connection Specifications](#).
- Make sure the graphic language setting is set to the correct setting, see [Changing the Graphics Language](#).

File Size and Memory

There is no direct relationship between file size on your computer and memory used in the printer to print that file. In fact, because of file compression (and general complexity) it is often impossible to estimate how much memory will be used. This means that some large prints will work fine, but some smaller prints may not and you will have to add more memory to your printer.



Printer does not Print

- You may have a power problem. If there is no activity at all from the printer, and power on indicator in the power switch on the front of the printer is off, check that the power cable is connected correctly and that there is power available at the socket.
- If you are using a Macintosh and the print job does not print, ensure the printer language is set to Postscript or Automatic. See [Changing the Graphics Language](#).
- You may have a problem with your application driver. Is your software configured for this printer? For general advice, see the *Setup Poster*. For advice specific to your software, see the documentation supplied with the driver.
- If you have connected your computer to the printer's parallel port or USB port and tried to print a binary-encoded PostScript file it will not print. The parallel and USB ports will only accept ASCII-encoded PostScript print files. The front panel will display the message "Error processing job / Flushing rest of job".
 - You will need to setup your application to encode the file in ASCII instead of binary and then send the job again through the parallel or USB port.
 - You could also connect your computer via the LAN connection of your printer and send the binary encoded PostScript print file again.
- The file may be too large for the printer's memory. This is the case if the front panel displays "Out of memory - data was lost". Look on your computer screen for any error message; some drivers allow you to choose a different printing mode and try to send the file again.
- If you continue to have problems, see [Getting Help](#).



Printer Seems Too Slow

- Did you specify **Best** print quality level on the front panel? Best quality mode prints take longer to print.
- Did you specify the right media type when loading the media? For details of front-panel media types, see [Paper Types](#). To find out the printer's current media type setting, see [Obtaining Roll or Sheet Paper Information](#).
- The printhead may need replacing, see [Printhead Replacement](#)
- Did you specify a Manual Dry Time in the front panel. Change the dry time to Automatic see [Ink System](#).
- If the printer is in Fast mode and the file it is printing contains high density inked areas the printer may need to slow down to compensate.

Printer Waits Too Long to Print a Nest

Change the Nest wait setting. See [How Long does the Printer Wait for Another File?](#)



Getting Help

- [HP Customer Care](#)
Details about the HP Customer Care program.
- [What to Do Before You Call](#)
Information on what you should do before you contact your local HP Customer Care Center.
- [HP DesignJet Online](#)
How to get help and much more via the World Wide Web.



HP Customer Care

As your strategic support partner, we make it our business to help keep your business running smoothly. HP Customer Care offers award-winning support to ensure you get the most from your HP DesignJet.

The contact details for your local HP Customer Care Center are provided in the Hewlett Packard Customer Care booklet supplied with your printer.

HP Customer Care provides comprehensive, proven support expertise and leverages new technologies to give customers unique end-to-end support. Services include setup and installation, troubleshooting tools, warranty upgrades, repair and exchange services, phone and Web support, software updates, and self-maintenance services.

To find out more about HP Customer Care, please visit us at: www.hp.com/go/support.



What to Do Before You Call

1. Review the troubleshooting suggestions in this section:
 - In the relevant driver documentation supplied with this printer (for users sending PostScript files or those using Microsoft Windows).
 - If you have installed third party software drivers and RIPs refer to that user documentation.
2. If the problem appears to be related to your software application, first contact your software vendor.
3. If you still have difficulty, refer to the *HP Support Services* booklet shipped with this printer. This document contains a comprehensive list of various support services available to help solve printer problems.
4. If you do call one of the Hewlett-Packard offices, please have the following information available to help us answer your questions more quickly:
 - The printer you are using (the product number and the serial number, found on the label at the back of the printer).
 - The computer you are using.
 - Any special equipment or software you are using (for example, spoolers, networks, switch-boxes, modems, or special software drivers).
 - The cable you are using (by part number) and where you purchased it.
 - The type of interface used on your printer (parallel, or network).
 - The software name and version you are currently using.
 - If the problem is a system error it will have a error number; record the error number and have it ready. See [Printer does not Print](#).



HP DesignJet Online

Direct access to HP and the information you want, when you need it. Register now!

www.hp.com/go/designjet

HP DesignJet Online is a free, web-based “user club” exclusive to HP DesignJet users. Having registered, the user has unrestricted access to a range of useful services, the emphasis being on “useful”, as this is definitely *not* a sales-oriented site.

Communication from HP to users includes:

- a quarterly newsletter focussing on usage tips, technical briefings and examples of HP DesignJet applications around the world;
- full information on worldwide HP Customer Care contacts;
- an on-line *HP DesignJet Diagnosis* troubleshooting tool;
- a calendar of HP DesignJet-related events and programs;
- on-line access to training videos and selected user documents;
- and immediate information on new products.

Communication from the users to HP includes:

- feedback on HP DesignJet features;
- automatic contact with HP Customer Care from the troubleshooting tool, for HP to follow up;
- and the chance to ask technical questions on large-format printing to industry experts.

And finally, communication from user to user includes the chance to win prizes by submitting HP DesignJet success stories, as well as a user-to-user discussion forum where users can share best practices and ask for advice from their fellow professionals.

HP DesignJet Online is available in English, German, French, Italian, Spanish and Portuguese.



Front Panel

The printer's front panel is a user-friendly interface that gives you access to a comprehensive set of printer functions. There is also information on your ink consumable items which is continually updated.

- [The Front Panel](#)
- [Menu Structure](#)
- [Navigating the Menu System](#)
- [Message Descriptions](#)



The Front Panel

The panel on the front of your printer is the principal way of changing the behavior of the printer, apart from any software driven controls that may be provided through the application in use. The front panel of the printer contains the following functional areas:

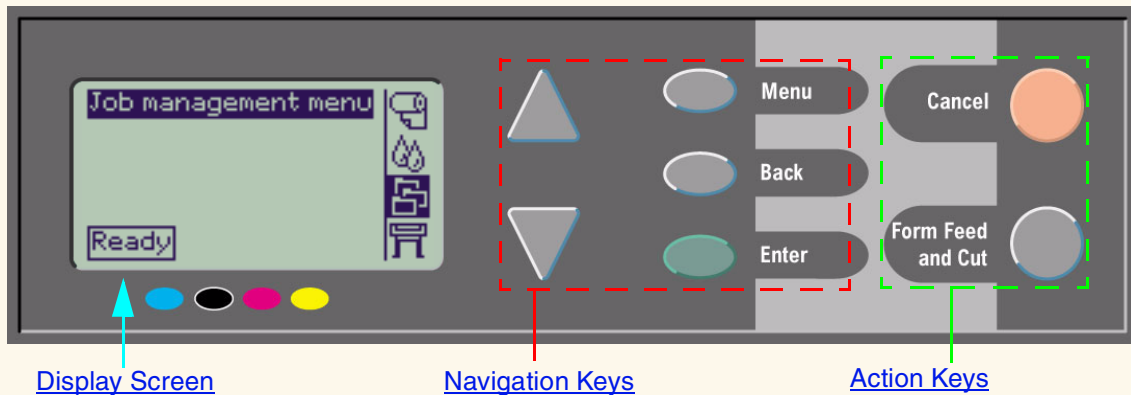



Navigation Keys

The display section of the front panel consists of an LCD display and the following five navigation keys:

The following navigation keys are provided to navigate through the menus displayed on the screen:

- The **Up** ▲ and ▼ **Down** keys let you scroll through the various items in a menu list.
- The **Menu** key takes you to the main screen. It **cancels** any choices that have not yet been selected by pressing the **Enter** key.
- The **Back** key takes you to the previous screen.
- The **Enter** key selects the item in the menu list and makes it current. If there are sub-selections to be made, this key takes you to them; otherwise it takes you back a screen.

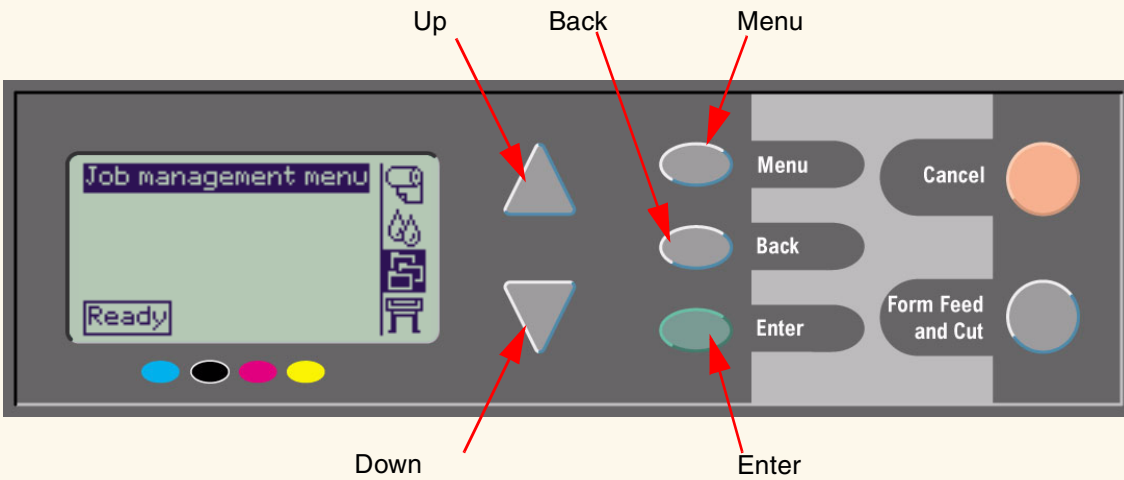

Display Screen

The display screen of the front panel shows the main menu (the words displayed may vary).

NOTE: You can always reach the main menu by pressing the Menu key.

After a short time-out, the display will always revert to the main menu with the **Job Management** menu active.

Active menu

Information message

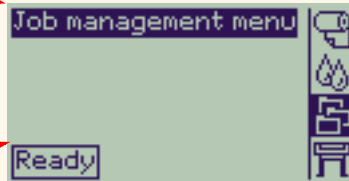

Paper Menu Icon

Ink Menu Icon

Job Management Menu Icon (Active)

Setup Menu Icon

[Navigation Example](#) are given from the **Job Management** menu.

Error Message





Action Keys

The **Cancel** key cancels the current printer operation (printing or preparing for printing). It will also cancel the current menu selection and return to the main menu if a menu option is highlighted.

The **Form Feed and Cut** key causes a sheet to be ejected or the roll to be advanced and cut.

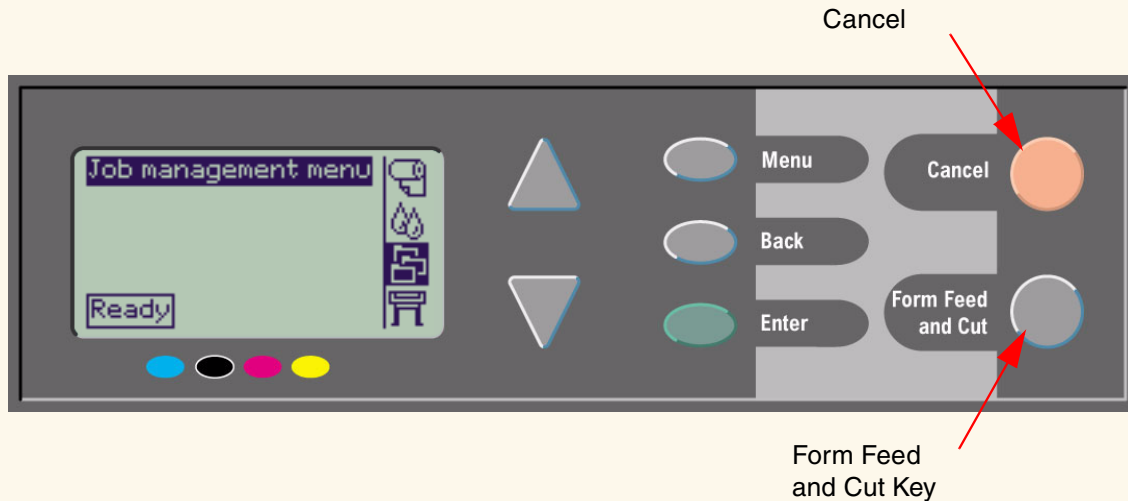

Menu Structure

The front panel display area screen shows the four classes of menu options available represented with specific icons. Click on the icon to displays its menu structure.

-  [Paper Menu](#)
-  [Ink Menu](#)
-  [Job Management Menu](#)
-  [Set-up Menu](#)





Paper Menu

Click on menu item to go to relevant topic.

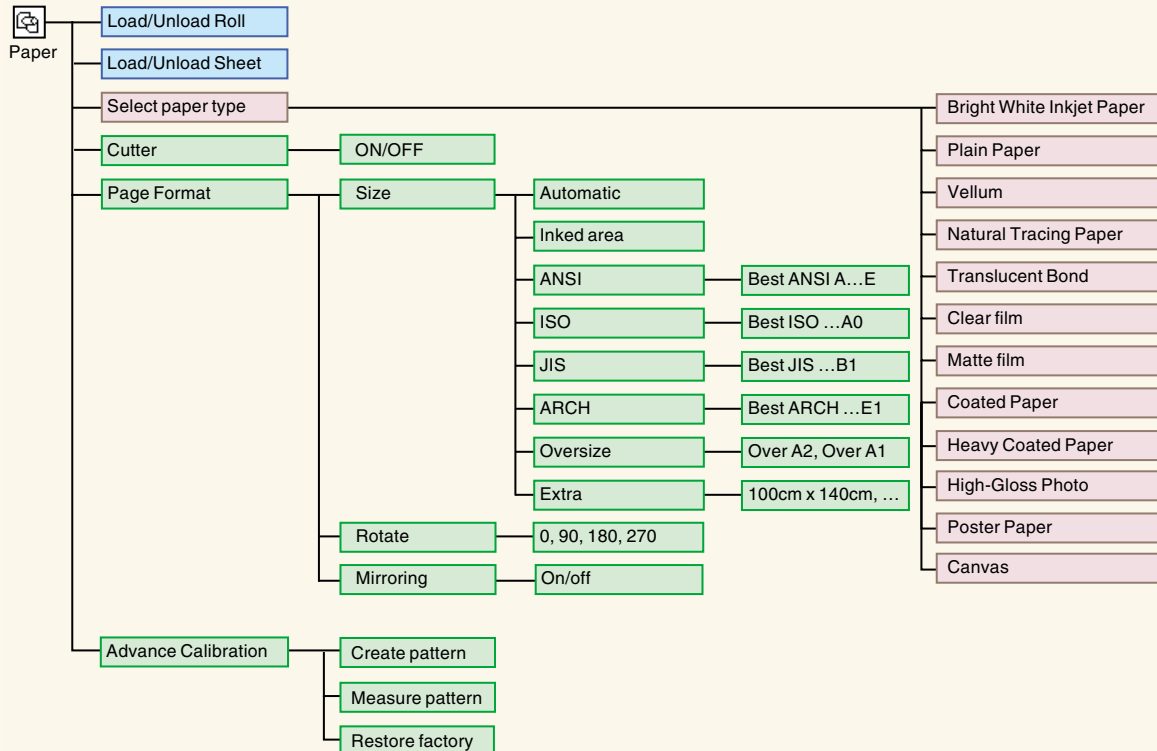

Menu item depends on the type of media loaded



Only shown if media is loaded



Items always shown





Ink Menu

Click on menu item to go to relevant topic.

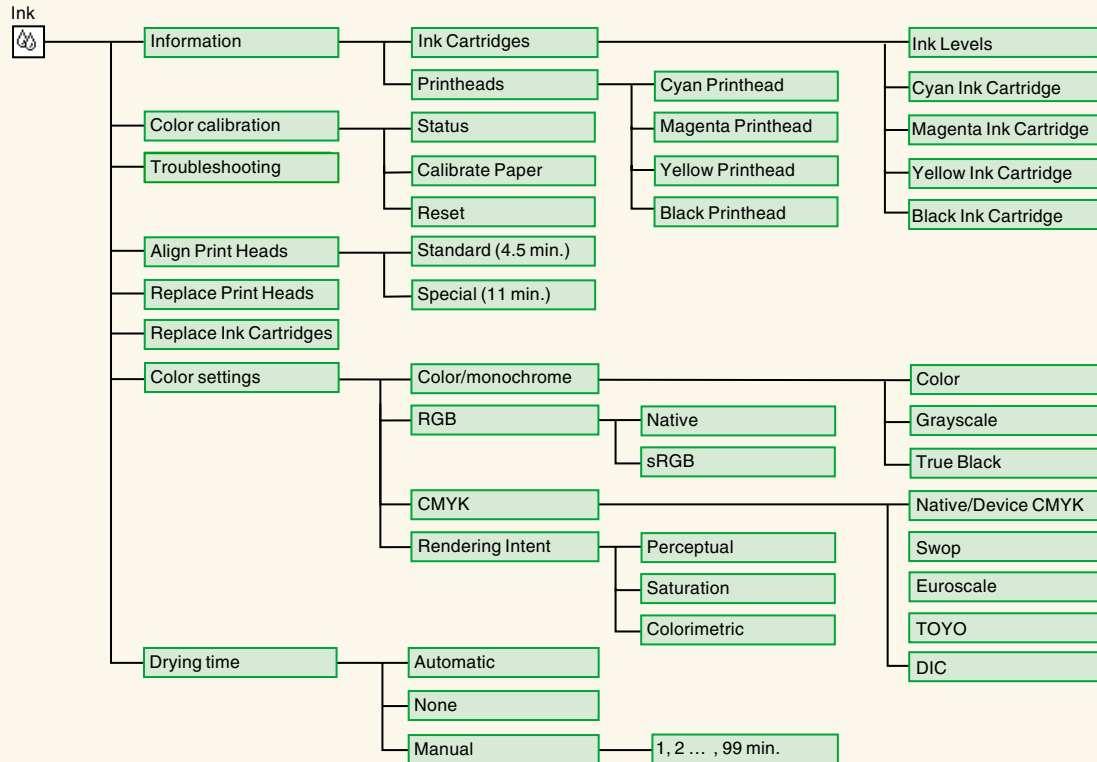



Job Management Menu

Click on menu item to go to relevant topic.

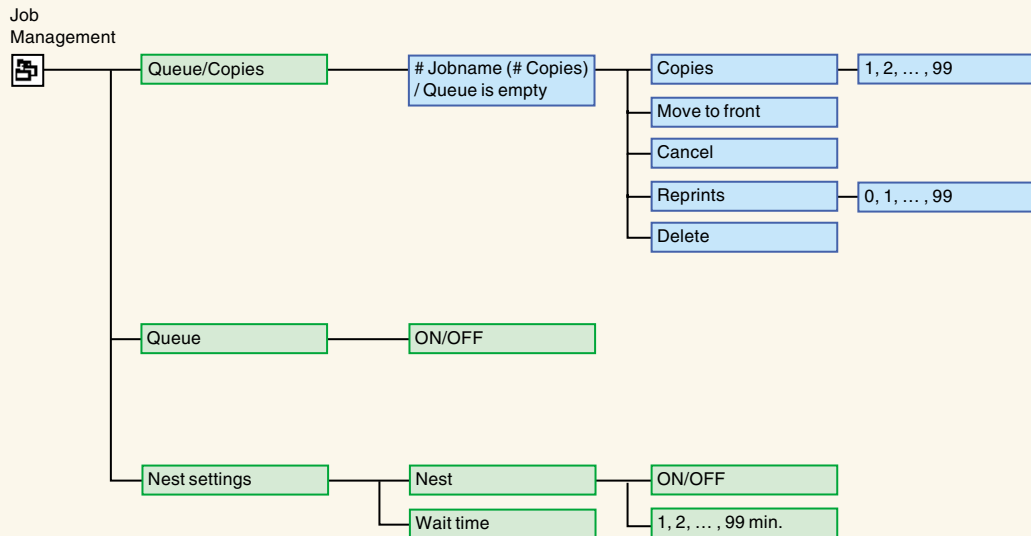

 Menu items depend on the state of the job queue or on the state of the currently selected job



Set-up Menu

Click on menu item to go to relevant topic.

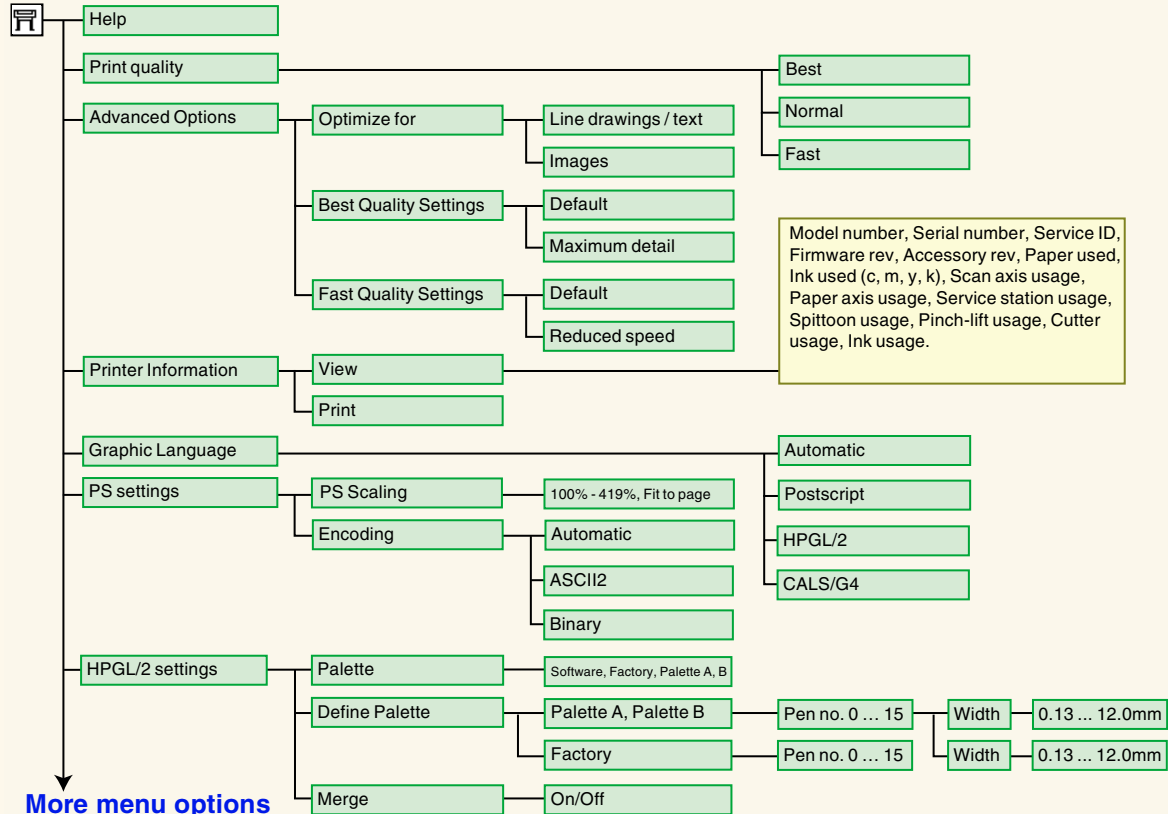

[More menu options](#)

Set-up Menu continued

Click on menu item to go to relevant topic.

[Previous menu options](#)

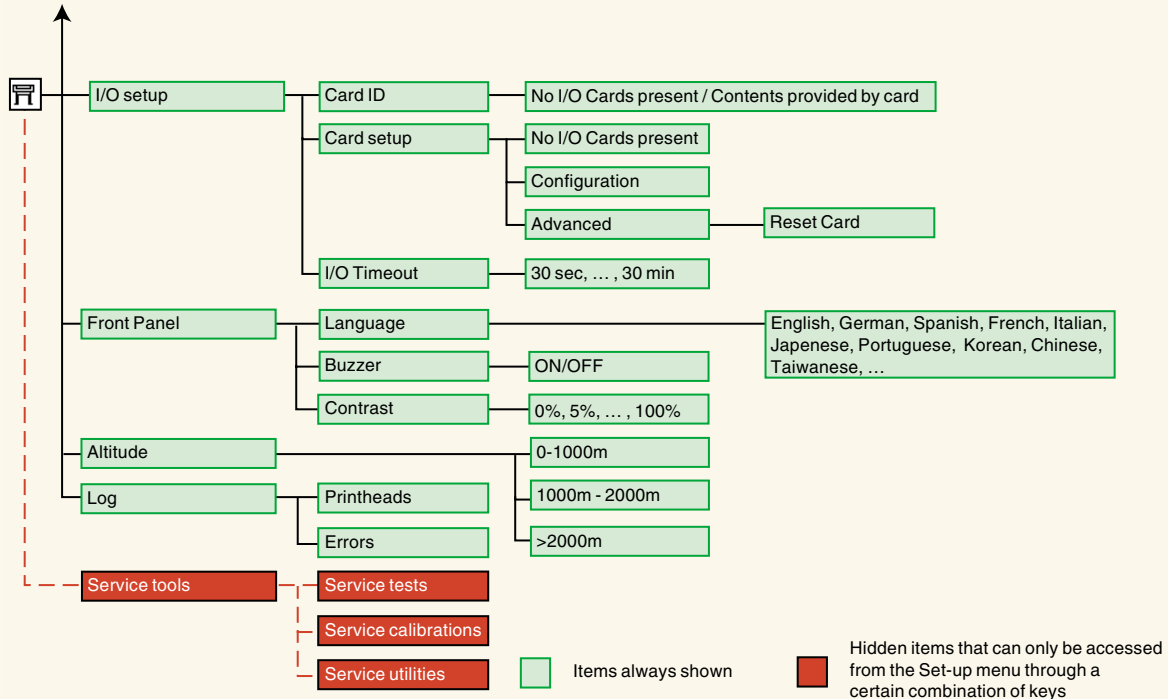

Navigating the Menu System

From the top level of the menu system, you can navigate through the menus using the display keys. Any menu item followed by a greater than symbol (>), indicates that a further level of menu items is available.

Press **Back** to return to the previous menu level without changing any menu selections.

Press **Menu** to return to the top level without changing any menu selections. This will bring you to the four menu icons.

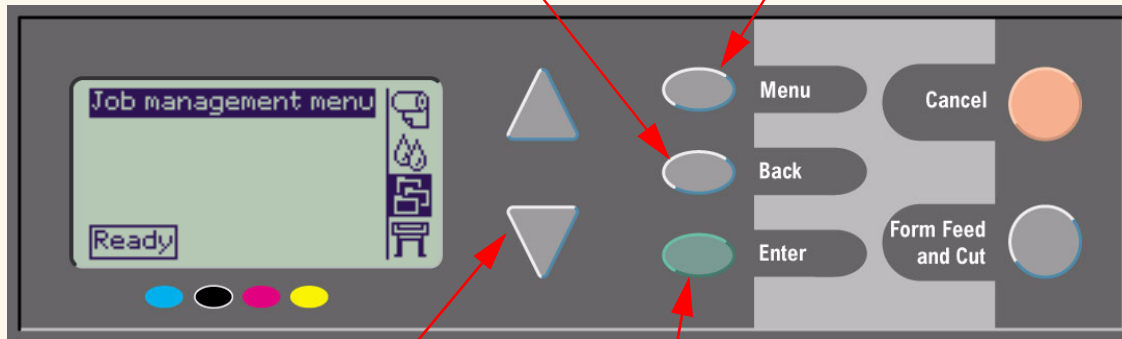

Press the **Up** ▲ and **Down** ▼ keys to scroll up and down through the menus or menu options.

Press **Enter** to:

- Select a menu and move to the next menu level.
- Change the value of the selected menu item.

See [Navigation Example](#) for a brief overview of the menu system.



Navigation Example

This section provides a typical example of how to navigate through the menus to configure a specific print option.

How to set the ink-drying time to three minutes

The Front Panel Menu Structure diagram for the [Ink Menu](#) shows that the path to the Drying time option is:

Ink menu  → **Drying time**

Use the following procedure to set the ink-drying time to three minutes.

Setting Drying Time Navigation Example

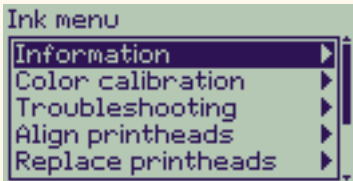
Key Action	Display	Result
1. Use the Up ▲ and Down ▼ keys to highlight the Ink menu icon.		The Ink menu icon is highlighted to allow you to select the Ink menu options.
2. Press the Enter key to enter the printer Ink menu.		The display shows the Ink menu to allow you to select Drying Time.

[Continued ...](#)

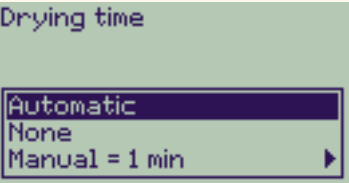
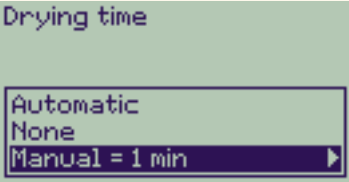

Setting Drying Time Navigation Example (Continued)

Key Action	Display	Result
3. Use the Up ▲ and Down ▼ keys to highlight the Drying time menu option.		The display shows the Drying time option highlighted.
4. Press the Enter key to enter the Drying time menu.		The display shows the Drying time menu to allow you to select the type of drying time you require.
5. Use the Up ▲ and Down ▼ keys to highlight the Manual menu option.		The display shows the Manual option highlighted.

[Previous ...](#)[Continued ...](#)

Setting Drying Time Navigation Example (Continued)

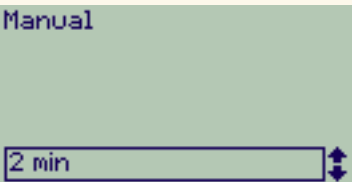
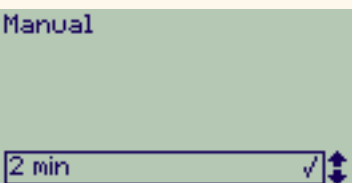
Key Action	Display	Result
6. Press the Enter key to enter the Manual drying time setting menu.		The display shows the Manual drying time setting menu to allow you to select the drying time you require.
7. Press the Up ▲ key once to select two minutes.		The display shows the Manual drying time setting menu with two minutes selected.
8. Press the Enter key to set the drying time to two minutes.		If the front-panel Buzzer is set ON, there will be a short 'beep' to confirm the change. A tick mark (✓) in the right side of the field confirms the value.

[Previous ...](#)[Continued ...](#)

Setting Drying Time Navigation Example (Continued)

Key Action	Display	Result
9. Press the Top key to return to the top level menu.		The display shows the Ink menu.

[Previous ...](#)

Message Descriptions

This is a list of the error messages in the front-panel display. If an action is needed, it is shown in *italics* in the **Explanation and Action** column. The messages are listed in alphabetical order. Other front-panel messages, such as prompts, are included in the descriptions of the relevant procedures elsewhere in this *document*.

Front Panel Messages

Message	Explanation and Action
Alignment error due to printheads. Press ENTER to see faulty printheads	The printer was aligning its printheads, but encountered an error due to some printheads not printing properly. Alignment has stopped. <i>Press the Enter key.</i>
Alignment error Press ENTER to continue	The printer was aligning its printheads, but encountered an error. Alignment has stopped. <i>Press the Enter key.</i>
Cartridges will expire in days: nn	One or more of the cartridges are about to expire. nn is the number of days until expiry date of the cartridge that will expire first. The cartridges that are about to expire are indicated below this message. <i>For an explanation of the replacement procedure, see Ink Cartridge Replacement.</i>
Color calibration error Press ENTER to continue	The printer was performing a calibration of its color system, but encountered an error. <i>Press the Enter key.</i>

For more Messages, click on the Next Page button



Front Panel Messages (Continued)

Message	Explanation and Action
<p>Error Select Replace Printheads</p> 	<p>The printer has detected that one or more of the printheads is missing or has an error, as indicated by flashing crosses. The four icons refer from left to right to the Cyan (●), Black (●), Magenta (●) and Yellow (●) printheads.</p> <p><i>For an explanation of the replacement procedure, see Printhead Replacement.</i></p>
<p>HP is not responsible for damage from use of non-HP ink.</p> <p>Replace Continue</p>	<p>The printer has determined that one or more of the ink cartridges is not an HP product. Your product warranty only applies when you use HP ink. Any damage caused to your printer resulting from the use of non-HP ink cartridges is not the responsibility of Hewlett-Packard.</p> <p><i>If you want to replace the non-HP ink cartridges, select Replace and press the Enter key. Otherwise, select Continue and press Enter to continue.</i></p>
<p>HP is not responsible for damage from use of non-HP printheads.</p> <p>Replace Continue</p>	<p>The printer has determined that one or more of the printheads is not an HP product. Your product warranty only applies when you use HP printheads. Any damage caused to your printer resulting from the use of non-HP printheads is not the responsibility of Hewlett-Packard.</p> <p><i>If you want to replace the non-HP printheads, select Replace and press the Enter key. Otherwise, select Continue and press Enter to continue.</i></p>

For more Messages, click on the Next Page button



Front Panel Messages (Continued)

Message	Explanation and Action
<p>Ink cartridge replacement required</p> 	<p>The printer has detected that one or more of the ink cartridges is missing or has an error, as indicated by flashing crosses. The four icons refer from left to right to the Cyan (C), Black (K), Magenta (M) and Yellow (Y) cartridges.</p> <p><i>For an explanation of the icons and details of the replacement procedure, see Ink Cartridges.</i></p>
<p>INK CARTRIDGES need to be functional. Replace before replacing printheads</p>	<p>You have attempted to replace printheads, but the printer has detected that there are ink cartridges that are wrong. The ink cartridges must be replaced before the printheads can be replaced.</p> <p><i>First replace the faulty, empty or missing ink cartridges and then replace the printheads. See Ink Cartridge Replacement and Printhead Replacement.</i></p>
<p>Install missing cartridges and replace empty cartridges before replacing printheads</p>	<p>You are replacing printheads, but the printer has detected that some cartridges are empty and some are missing. The empty cartridges must be replaced and the missing ones inserted before the printheads are replaced.</p> <p><i>Follow the procedure for Ink Cartridge Replacement. Press the Enter or Cancel key to continue.</i></p>

For more Messages, click on the Next Page button



Front Panel Messages (Continued)

Message	Explanation and Action
Install missing cartridges before replacing printheads	<p>You are replacing printheads, but the printer has detected that one or more cartridges are missing. The missing cartridges must be installed before the printheads are replaced.</p> <p>Follow the procedure for Printhead Replacement. Press the Enter or Cancel key to continue.</p>
Open window and check printhead cover is properly closed	<p>You have replaced one or more printheads and the printer's check has found that the printhead cover is not securely closed.</p> <p>Open the window and check the printhead cover. The procedure is described in the Printhead Replacement procedure.</p> <p>Note: This message may also appear following a paper jam, as the printer cannot detect the exact reason for the problem. In this case you may have to resort to powering off the printer or even removing the power cable from the machine, in order to recover from the problem. See Clearing a Media Jam.</p>
Open window and check proper installation of setup printheads	<p>During system start-up, which occurs when you first install the printer, you need to install the setup printheads. These special printheads cannot be used for printing, but must be used when the printer has been powered off. The printer has detected that the setup printheads have not been installed correctly.</p> <p>Open the window and follow subsequent instructions to reinstall or relocate the setup printheads. Contact HP for advice if the setup printheads are missing or cannot be installed correctly.</p>

For more Messages, click on the Next Page button



Front Panel Messages (Continued)

Message	Explanation and Action
Option not available now	You have selected an option in the menu that is not available at the moment. (The printer may be busy, out of ink, out of paper, etc.)
Out of paper	The printer ran out of paper while printing the calibration pattern. <i>Load a sheet or roll that is at least 65 cm (25 inches) long and 50 cm (20 inches) wide.</i>
Paper advance calibration is recommended. Press ENTER to calibrate	You are recommended to perform the Advance calibration routine, to ensure the optimum print quality. <i>Press the Enter key to create the calibration pattern. See Advance Calibration.</i>
Paper advance calibration is recommended. Load paper and select Paper advance calibration. Press ENTER to finish	You are recommended to perform the Advance calibration routine, to ensure the optimum print quality. <i>Load a sheet or roll of paper and then select Advance calibration from the Paper menu. See Advance Calibration.</i>
Paper loaded with too much skew Press ENTER to retry Press CANCEL to abort	During the loading of paper, the printer has detected that the paper is skewed too much, that is, it has not been loaded straight enough. ('Skew' is the angle between the actual paper edge and the correct line.) <i>Either: Press the Enter key to restart the loading procedure; Or: Press the Cancel key to cancel paper loading.</i>

For more Messages, click on the Next Page button



Front Panel Messages (Continued)

Message	Explanation and Action
Paper mispositioned	The paper is not properly positioned in the printer. Either it is out of the load line margins or it has moved too much from its previous position. <i>Reload the paper following the normal procedure, to solve this problem. See Loading Roll Media and Loading Sheet Media.</i>
Paper not found Press ENTER to retry Press CANCEL to abort	During the loading of paper, the printer has detected that no paper has been loaded. Either: Press the Enter key to restart the loading procedure; Or: Press the Cancel key to cancel paper loading.
Paper not present. Load paper to print calibration pattern	The paper axis calibration routine has been triggered with out having paper loaded. <i>Load paper; see Advance Calibration for details of the routine.</i>
Paper too big to scan the pattern after printing it	During the paper loading for the Calibration routine, the printer has detected that the it will not be able to load the later when it will be needed for scanning. The minimum size required for the print is 65 cm (25 inches) long and 50 cm (20 inches) wide. <i>Load a smaller sheet that satisfies this minimum requirement.</i>

For more Messages, click on the Next Page button



Front Panel Messages (Continued)

Message	Explanation and Action
Paper too big Press ENTER to retry Press CANCEL to abort	While loading paper into the printer (roll or sheet), the printer has found that it is either too wide or too long (only for sheet) to be loaded properly. <i>Press the Enter key to load smaller paper, or the Cancel key to stop the load.</i>
Paper too small for a diagnostic print	The Troubleshooting utility has found that the single sheet loaded in the printer is too small for a Diagnostic Print . <i>Load a roll of paper, or a sheet that is A3-size or larger.</i>
Paper too small to align printheads Load bigger size to align Press ENTER to continue	The paper loaded is not big enough to contain the alignment pattern. <i>Unload the paper (select Unload roll or Unload sheet from the Paper menu) and then load paper that is large enough—at least A4/ Letter-size in landscape mode for Standard alignment, or A3/B size in landscape mode for Special alignment.</i>
Paper too small to print the pattern	The paper loaded is not big enough to contain the paper axis calibration pattern. <i>Load a roll or sheet that is at least 65 cm (25 inches) long and 50 cm (20 inches) wide.</i>

For more Messages, click on the Next Page button



Front Panel Messages (Continued)

Message	Explanation and Action
Paper too small Press ENTER to retry Press CANCEL to abort	While loading paper into the printer (roll or sheet), the printer has found that it is either too narrow or too short (only for sheet) to be loaded properly. <i>Press the Enter key to load larger paper, or the Cancel key to stop the load process.</i>
Paper type not valid to align printheads Change paper type to align Press ENTER to continue	You have requested the printer to align paper but it has detected that the paper loaded is not the right type to use to align the printheads. The paper loaded is not big enough to contain the alignment pattern. <i>Unload the paper (select Unload roll or Unload sheet from the Paper menu) and then load paper that is the right type for the alignment. See Printhead Alignment.</i>
Pattern not found Reload it again, please	The printer is trying to perform a scan of the calibration pattern, but the pattern was not found. <i>Reload the sheet that was printed by the Create pattern part of the calibration routine.</i>
Possibly a paper jam 1. Open window 2. Switch power off 3. Clear paper path 4. Switch power on 5. Align printheads	There may be paper jammed in the printer. (The printer has detected that a motor is blocked and the likely cause is a paper jam; however, it may be due to some other cause.) <i>Follow these steps to check the paper path, as described in Clearing a Media Jam. When the jammed paper has been cleared, you are strongly recommended to align the printheads, as they are quite likely to have become misaligned as a result of the paper jam.</i>

For more Messages, click on the Next Page button



Front Panel Messages (Continued)

Message	Explanation and Action
<p>Printhead replacement not available now. Cancel print jobs before replacement</p>	<p>You have requested the printer to replace one or more printheads, but the printer is busy printing a job and cannot honor the request now.</p> <p>Either: press the Cancel key to cancel the job that is currently printing, and then again select Replace Printheads (from the Ink system menu).</p> <p>Or: wait until the job has finished printing (and there are no more jobs in the print queue), and then again select Replace Printheads (from the Ink system menu).</p>
<p>Printhead warning Poor print quality</p> 	<p>A problem has occurred with one or more printheads. The printheads are still functional. The problem was detected either during printhead alignment or during troubleshooting. If you have completed the routine, the system was unable to clean the printheads fully.</p> <p>You should use the Troubleshooting Procedure to correct any image quality problems that may be apparent; alternatively, you should replace the printheads (see Printhead Replacement).</p>
<p>Printheads not aligned Paper type not valid to align printheads Press ENTER to continue</p>	<p>You have replaced one or more printheads but the printer has detected that you do not have the right type of paper loaded for the alignment process.</p> <p>Press the Enter key to load the correct type of paper, or the Cancel key to stop the load process.</p>

For more Messages, click on the Next Page button



Front Panel Messages (Continued)

Message	Explanation and Action
Printheads not aligned Paper too small to align printheads Press ENTER to continue	You have replaced one or more printheads but the printer has detected that you do not have wide enough paper loaded for the alignment process. <i>Press the Enter key to load larger paper, or the Cancel key to stop the load process.</i>
PRINTHEADS not functional Replace printheads Cancel print	The printer is attempting to print a job, but finds that there is a problem with the printheads. You may either replace the printheads at this stage or cancel the print. <i>Select the required option and press the Enter key. If you decide to replace them, you will be told which ones are failing or missing.</i>
Printheads require alignment. Load paper and select Align printheads. Press ENTER to finish	The printer has detected that the printheads need to be aligned. <i>Press the Enter key to continue. Load a sheet or roll of paper, and select Align printheads from the Ink menu. See Printhead Alignment.</i>
Printheads require alignment. Press ENTER to align	The printer has detected that the printheads need to be aligned. <i>Press the Enter key to align them. See Printhead Alignment.</i>
Problem found during calibration	A general problem was found during the Advance Calibration routine. <i>Respond to any other messages that appear on the front panel, indicating ink or paper problems, and then retry the Advance calibration routine.</i>

For more Messages, click on the Next Page button



Front Panel Messages (Continued)

Message	Explanation and Action
Problems detected in INK CARTRIDGES. Continue process and replace them. Press ENTER to continue	There is an error with the ink cartridges during the preparation of the ink system. <i>Press the Enter key and then follow the instructions to replace the faulty ink cartridges.</i>
Reload paper	There is an error in the paper, as shown in another message. <i>Use the normal procedure to reload the paper.</i>
Replace empty cartridges before replacing printheads	You have requested the printer to permit the replacement of printheads, but the printer has detected that one or more cartridges are empty. The empty cartridges must be replaced before the printheads are replaced. <i>Press the Enter key and follow the procedure for replacing empty cartridges, described in Ink Cartridge Replacement.</i>
Right edge of roll too far from load line Press ENTER to retry Press CANCEL to abort	The paper is out of the load line margins—too far from the line where it should be loaded. Either: Press the Enter key to restart the loading procedure; Or: Press the Cancel key to cancel paper loading.

For more Messages, click on the Next Page button



Front Panel Messages (Continued)

Message	Explanation and Action
Right edge of sheet too far from load line Press ENTER to retry Press CANCEL to abort	During the loading of a sheet of paper, the printer has detected that the paper is too far to the left; it should be aligned close to the blue line painted on the right side of the platen. Either: Press the Enter key to restart the loading procedure; Or: Press the Cancel key to cancel paper loading.
Roll edge not found Please check roll edges are non-clear Press ENTER to retry Press CANCEL to abort	During the loading of a roll, the printer cannot detect the side edge of the paper. A possible cause is that the media is transparent (clear); only non-clear media are supported. Either: Press the Enter key to restart the loading procedure; Or: Press the Cancel key to cancel paper loading.
Roll right edge too far from load line Press ENTER to retry Press CANCEL to abort	During the loading of a roll of paper, the printer has detected that the paper is too far to the left; it should be aligned with the blue line painted on the right side of the platen. Either: Press the Enter key to restart the loading procedure; Or: Press the Cancel key to cancel paper loading.
Sheet edge not found Please check sheet edges are non-clear Press ENTER to retry Press CANCEL to abort	During the loading of a sheet, the printer cannot detect the side edge of the paper. A possible cause is that the media is transparent (clear); only non-clear media are supported. Either: Press the Enter key to restart the loading procedure; Or: Press the Cancel key to cancel paper loading.

[For more Messages, click on the Next Page button](#)



Front Panel Messages (Continued)

Message	Explanation and Action
Sheet not loaded Load sheet with printed pattern	The printer is trying to perform a scan of the calibration pattern, but no sheet was found. <i>Load the sheet that was printed by the Create pattern part of the calibration routine.</i>
Sheet too long Please check it is not a roll Press ENTER to retry Press CANCEL to abort	You have requested the printer to load a sheet of paper, but the sheet appears to be too long. <i>Check that the paper is not a roll.</i> Either: Press the Enter key to try to load the sheet again; Or: Press the Cancel key to stop the process. If the paper is on a roll, follow the instructions in Loading Roll Media .
Troubleshooting finished Resume normal printing If problem persists select Troubleshooting again Press ENTER to continue	The printer has finished the Troubleshooting routine and will not at this stage perform further cleaning on the printheads because this could damage the other ones. However, according to the evaluation you have given, the printheads require cleaning because there are defects in the Diagnostic Print. <i>Press the Enter key. Then resume your normal printing activities. If the problem recurs, try using the Troubleshooting routine again, or select Replace Printheads from the front panel (in the Ink System menu) to replace the printheads that are faulty.</i>
Troubleshooting requires paper for a diagnostic print.	The Troubleshooting utility has found that there is no paper loaded in the printer. <i>Load a roll of paper.</i>

For more Messages, click on the Next Page button



Front Panel Messages (Continued)

Message	Explanation and Action
Unable to initialize ink system. Call HP representative.	The system cannot successfully complete the startup. <i>Call HP for service.</i>
Unable to prepare ink system. Open window to check SETUP printheads	During ink system start-up, the purge of the ink system has failed and the system is asking you if the preparation has completed. <i>Check the setup printheads and then follow the instructions in the front panel and respond to further questions.</i>
Unknown ink cartridges. Press ENTER to continue.	The ink cartridges are not recognized by the printer as ink cartridges approved by HP, and there is at least one that is new. <i>Press the Enter key.</i>
Unknown paper format Reload paper	The format (roll or sheet) of the paper loaded in the printer is unknown. <i>Reload the paper following the normal procedure, to solve this problem. See Loading Roll Media or Loading Sheet Media.</i>
Unknown paper type Select paper type	The type of the paper loaded in the printer is unknown to the printer. <i>Select a known paper type from the printer menu.</i>
Unknown printheads. Press ENTER to continue.	The printheads are not recognized by the printer as printheads approved by HP, though the printer can still use them. <i>Press the Enter key.</i>

For more Messages, click on the Next Page button



Front Panel Messages (Continued)

Message	Explanation and Action
Warning! Machine calibrations need to be performed. Refer to guide for instructions.	The color calibrations for the paper that is loaded have been lost. Follow the procedure described in Advance Calibration .
Warning: color calibration not done on this paper type	The printer has detected that the color calibrations have not been performed on this paper type, and the system is configured to do them. <i>To calibrate color for the current paper type, select Ink menu → Color calibration → Calibrate paper.</i>
Warning: printheads not aligned	The printer has detected that the printheads have not been aligned since the last replacement. <i>You should align the printheads by selecting Align printheads from the Ink menu.</i>



Printer Options

The printer has many options that you can use to ensure that the image you print has the look and appearance you want. You can select printer settings either from the front panel or from the driver you have for the printer. In most cases the driver settings override the front panel settings.

The Print Options Tab contains these topics:

- [Page Format](#) deals with the formatting of the image and how to use the settings to obtain the formatting that you want. It also explains how to control the orientation of the image on the media.
- [Setting Page Size in the Front Panel](#) explains how to set the page size from the front panel.
- [Image Appearance](#) describes how to control the overall appearance of your prints.
- [Print Management](#) describes how to efficiently manage your printing.
- [Printer Configuration](#) details how to set specific configuration parameters of your printer.





Page Format

- [Page description](#) explains how to make sure the you obtain the prints from your printer in the format you want.
- [Rotating an Image](#) details on how to rotate the image.
- [Printing a Mirror Image](#) explains how to print a mirror image of your print.
- [Scaling the Image](#) explains how to scale your image from the front panel.





Page description

This section explains how to make sure that the printer produces your print in the page format you want.

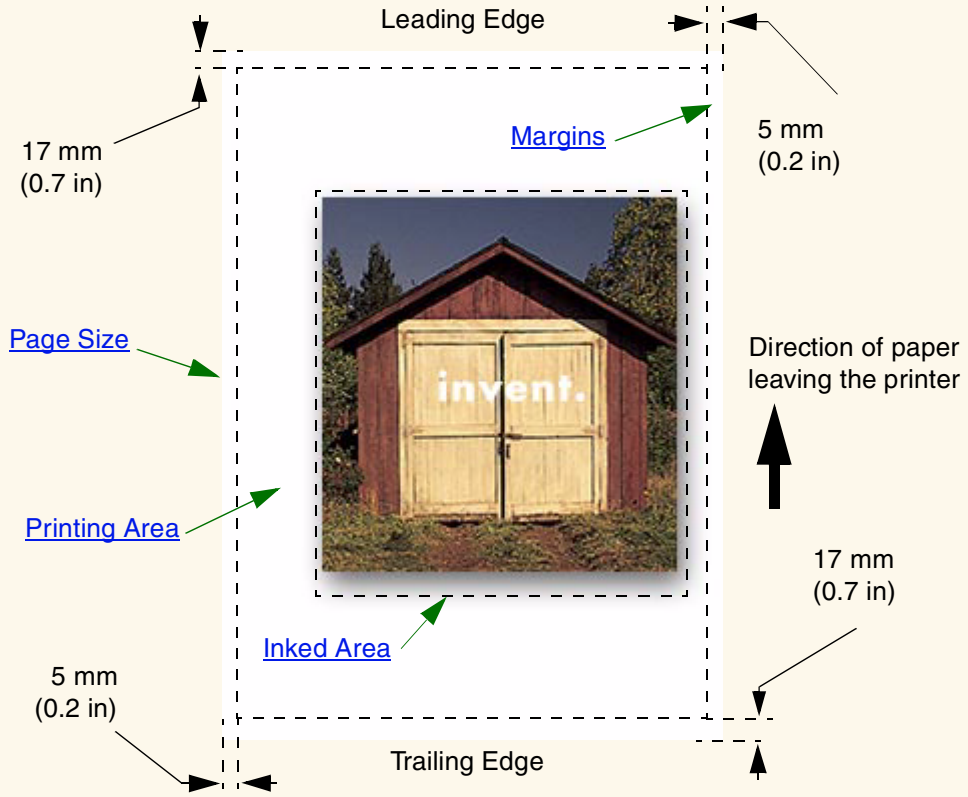



Page Size

Page size can be specified from the front panel or in the software, where it may be called “Page Size”, “Media Size”, “Paper Size”, etc., and where the options include, for example, ISO A3, ANSI Letter, Custom. If your software does not define the page size in the print file, the front-panel setting is used. Otherwise, the software setting overrides the front-panel setting.

NOTE: There is one exception to the above. If the front-panel setting is Inked area and you are sending a PostScript file, the front panel setting is used. See Inked area below.

Margins

The margins are set to ensure the maximum printable area on your paper. The two side margins are 5.0 mm. The [margin](#) settings for the leading and trailing edges are 17 mm.

Printing Area

The [printing area](#) is the page size minus the margins. For a table showing the printing areas for standard paper sizes, see [Printable Area](#).

Inked Area

inked area is the smallest rectangle that contains the entire image.





Rotating an Image

These topics detail all aspects of job rotation:

- [Job rotation via HP PostScript driver](#)
- [Job Rotation \(HP-GL/2\)](#)
- [Page Size and the Rotation](#)
- [What is Rotated?](#)





Job rotation via HP PostScript driver

By default the jobs generated by any of the PostScript drivers provided with the printer are printed in portrait, even if the image viewed in your application is in landscape orientation. In order to save paper you need to rotate the job through the Postscript driver interface.

Rotating a job is controlled by a setting in the PostScript driver, it can be enabled or disabled. When you enable the rotation feature both the page and the image are rotated 90 degrees counterclockwise.

Note that the HP driver will over-ride the setting in the front-panel.

NOTE: Consult the PostScript driver documentation to find out where you set the rotation feature.

Job Rotation (HP-GL/2)

If the software in the driver does not specify the rotation setting, it can be specified in the front panel (*Paper > Page Format > Rotate*).

Page Size and the Rotation

Note that when you rotate a job the page size is enlarged to avoid clipping, because the trailing and leading margins are not the same size as the side margins.

When rotating, the page size is enlarged across the paper direction to ensure that the drawing is not clipped.

Rotating a Job with a Third Party PostScript Driver

If you are using a third party PostScript driver, you can rotate the image using the rotate setting in the front panel (*Paper > Page Format > Rotate*). For more information consult the documentation of the third party driver.





What is Rotated?

With roll paper, both the image and the page orientation are rotated.

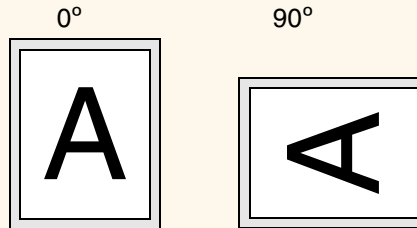

Notice that the narrow margins are always at the left and right sides, regardless of the orientation. The page size is adjusted to maintain the printing area, preventing clipping.

With sheet paper, the image is rotated, but the page orientation specified in your software is retained. (You should always load sheet paper in the orientation you have specified in the software.)

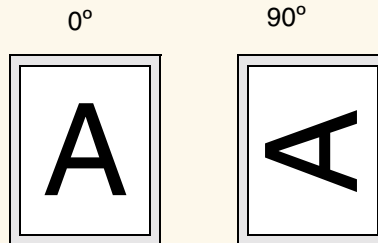



Printing a Mirror Image

If you are using clear imaging paper, sometimes called backlit, you may want to print a mirror image of your print, so that when the paper is lit from behind it is in the correct orientation. This can be done from the front panel, without changing the image in your software.

Mirror Off

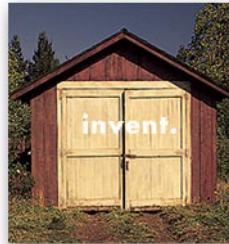

Mirror On

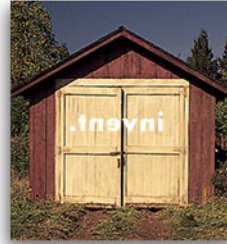



Scaling the Image

With a PostScript file, you can enlarge your printed image from the printer's front panel by using the *PS Scale* option, accessed from *Set-up > PS settings*.

The PS scale feature is useful:

- If your software does not support large formats.
- If your file is too large for the printer's memory, and you reduce the page size in your software and then scale it up again using the front-panel option.

Related Information

- [Scaling Factors](#)





Scaling Factors

To scale your ANSI A PostScript file to:

Required Size	ANSI B	ANSI C	Arch C	ANSI D	Arch D	Arch E1	ANSI E	Arch E
Use...	129%	200%	210%	258%	282%	352%	400%	419%

To scale your ISO A4 PostScript file to:

Required Size	ISO A3	ISO/JIS A2	OS A2	ISO/JIS A1	OS A1	ISO/JIS A0
Use...	129%	200%	210%	258%	352%	400%

The “Fit to page” setting adjusts the image size to the page size selected for your printer. For example, If you have selected ISO A2 as the page size and you print an A4-size image, it will be enlarged to fit the A2 page. If ISO A4 page size is selected, the printer would reduce a larger image to fit the A4 size.



Setting Page Size in the Front Panel

- [Adjusting the Page Size in the Front Panel](#)
Details how and why you would adjust the Page Size from the Front Panel.
- [Page Size](#)
Explains how PostScript Files interpret Page Size.
- [Page Size and Clipped Images](#)
Explains what happens if you choose a larger page size than the current media loaded in your printer.
- [Page Size and Nesting \(Roll Paper Only\)](#)
Explains how the Page Size effects Queueing and Nesting



Adjusting the Page Size in the Front Panel

You do not normally need to adjust the page size through the front panel, because the page size you have selected in your HP driver overrides the page size selected in the printer. However, some of the circumstances in which you may want to change the default setting are:

- When you are using the *PS Settings* → *PS Scale* → *Fit to page* feature. See [Scaling the Image](#).
- When you are not using one of the HP drivers supplied with your printer; for example, if you are sending a PostScript file from a UNIX application.
- When you want to save paper by printing only the inked area of your print, plus the margins. In this case set *Page Format* → *Size* → *Inked area*.

Depending on the driver you are using, you may not need to change the page size in the front panel. The default *Size* setting (Software) in the *Page Format* menu causes the printer to look for the page size information in the print file: if it is there, the printer uses it.

However, some of the circumstances in which you may want to change the default setting are:

- If you want to print the inked area only, but the driver you are using does not specify [“Inked Area”](#).

In this case, set the *Size* setting in the *Page Format* menu to *Inked area*.

If you can select *Inked area* from your driver, any selection you have made in the front-panel menu will be overridden by the settings in the driver.

- When the prints you are creating need to be of a specific standard (for example, ISO or ANSI), but the actual size within that standard is not important. For example, your page size may need to conform to a standard ISO page size, but it does not matter whether the final page size is ISO A4 or ISO A3.

In this case, set *Page Format* → *Size* to *ISO* → *Best...* or *ANSI* → *Best...* etc. The printer uses the smallest standard size into which the inked area will fit.



Page Size

Unless you are using the front-panel *Page Format* → *PS Scaling* → *Fit to page* option (see page [Scaling the Image](#)), the front-panel page-size settings have no effect on PostScript files that already contain page-size information, which includes all PostScript files sent using one of the HP DesignJet PostScript drivers supplied with this printer.

If you are using the *Page Format* → *PS Scaling* → *Fit to page* option, then the printer uses the page size set in the printer's front panel as follows:

- If the page size is set to a discrete size, it uses the specified page size.
- If the page size is set to Software, the printer calculates the page width as the width of the loaded paper, and the page length as 1.5 times the width of the loaded paper.
- If the page size is set to Inked area, the printer calculates the page width as the width of the loaded paper and the page length as the height of the inked area plus the top and bottom margins of the page.
- If the page size is set to a “Best...” option, the printer calculates the page length as 1.5 times the page width.



Page Size and Clipped Images

If you specify in your software a page size that is larger than the paper size loaded in the printer, the printer will still print what it can, but may clip your image.

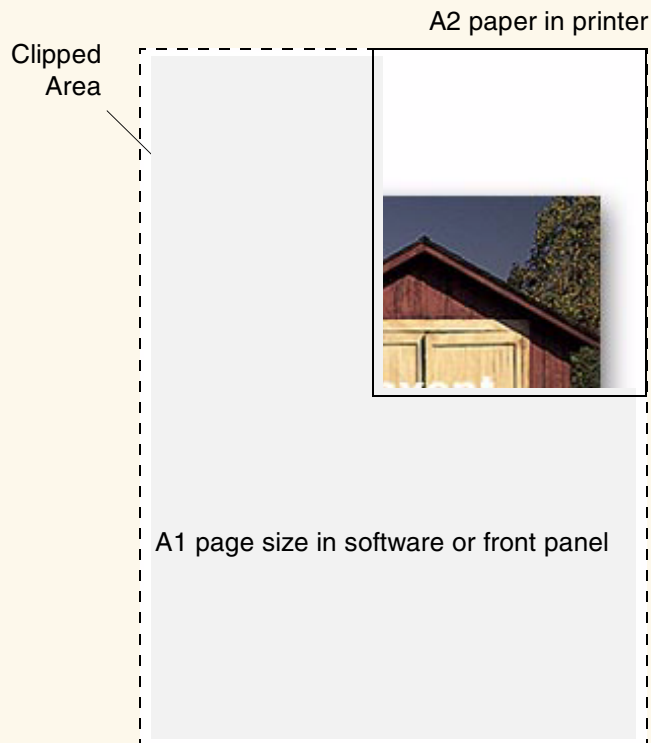

Page Size and Nesting (Roll Paper Only)

[Nesting](#) means placing two or more pages side-by-side on a roll to save paper. There are certain cases when your prints can not be nested. For a complete explanation of nesting, see page [Nesting Pages](#).

If you have [queueing](#) and nesting switched on, the printer will use the page size to determine which pages are nested and whether the pages can be automatically rotated when nesting. See page [When Does the Printer Try to Nest Pages?](#), for information about which pages can be automatically rotated.



Image Appearance

These topics explain how you can control the overall appearance of your prints.

- [Front Panel Image Options](#)
explains how to change the HP-GL/2 color palettes.
- [Printing Images in Grayscale](#)
describes how to print color images in [grayscale](#).
- [Print Speeds and Print Quality](#)
lists typical printing times by output quality.
- [Print Quality](#)
describes the different print modes that are available with your printer.
- [Advanced Options](#)
describes the various optimization and quality enhancement methods available.



Front Panel Image Options

These topics deal with the ways you can control the overall appearance of your prints from the **front panel** in terms of:

- [Pen Widths and Colors in the Internal Palettes](#)
- [Changing the Treatment of Overlapping Lines \(Merge\)](#)

Some front-panel selections affect the next file you send from your computer, not pages already in the printer's queue. If this is the case, it is stated in the relevant topic.

Some of the controls are available using the front-panel menus (for example) pen width, pen color, overlapping lines). Print mode options are controlled from the front-panel.

Why Use the Front Panel?

By default, the printer looks to your software to provide information on all the above attributes. However, your driver or application may not provide these controls or you may want to experiment with various effects, or try a temporary change, without the need to change your images or your driver settings.

Some of these settings do not affect the output generated when printing from most of the applications under Windows when using a HP-GL/2 driver.



Pen Widths and Colors in the Internal Palettes

The “pens” discussed throughout these topics are the conceptual pens in a software [palette](#), rather than the printer’s physical printheads.

The printer has three pen palettes:

- Factory
- Palette A
- Palette B.

The factory palette cannot be changed. You can, however, change the line width and color settings for each pen in the remaining two palettes (palette A and palette B). Initially, all three palettes are identical. Each palette has 16 pens which can include pens of different widths and any combination of the printer’s predefined 256 colors.

Related Information

- [To Select a Palette](#)
- [Change the Palette Settings](#)
- [How to define Palette A](#)



To Select a Palette

To select a palette through the front-panel menu, go to the Define Palette selection under HP-GL/2 Settings and choose the palette you want. See [Set-up Menu](#).

The following table describes the palette choices.

Palette	Comments
Software	The printer looks to your software for pen settings and ignores all three internal palettes.
Palette A	The printer assigns the attributes defined in Palette A to the pens defined in your software as 0 through 15.
Palette B	The printer assigns the attributes defined in Palette B to the pens defined in your software as 0 through 15.
Factory	The printer assigns the attributes defined in the Factory Palette to the pens defined in your software as 0 through 15.



Change the Palette Settings

You cannot change the Factory palette, but you can define Palettes A and B to be whatever you choose. The defaults are Palette, width:

Item	Available Options	Defaults
Palettes	Factory, A, B.	Factory
Pens	0 through 15.	
Widths (mm)	0.13, 0.18, 0.25, 0.35, 0.50, 0.65, 0.70, 0.80, 0.90, 1.00, 1.40, 2.00, 3.00, 5.00, 8.00, 12.00. Note that 0.13 mm is a one-pixel line width at 300 dpi and three-pixels line width at 600 dpi	.13mm
Colors	0 through 255.	As specified on the Palette Print.

[How to define Palette A](#)



How to define Palette A

The following steps explain how to define Palette A.

Instructions	Select (using the  keys)	Then Press:
1.	Set-up menu	Enter
2.	HP-GL/2	Enter
3. Select Palette A	Define palette	Enter
4.	Palette A	Enter
5. Select pen to change (in this example 3).	Pen 3	Enter
6. The current width assigned to this pen is displayed, for example Width=0.13mm.	Width = 0.13mm	Enter
7. Scroll to the width you want.	0.35mm	Enter > Back
8. Scroll to Color. The current color assigned to the pen is displayed (in this example 4)	Color = 4	Enter
9. Scroll to the color you want.	Color = 110	Enter > Back
10. If both width and color are correct (for Pen 3), press Back four times	Pen 3	Top

Repeat this procedure to define each of the other pens.

NOTE: The palette you have just defined will take effect only when you select it to be the current palette, as explained on To Select a Palette.



Changing the Treatment of Overlapping Lines (Merge)

The Merge setting controls the overlapping lines in an image. There are two settings, Off and On. The following illustration shows the effect of each setting.

Merge off (Default)

A subsequent line hides a previous line where they overlap.

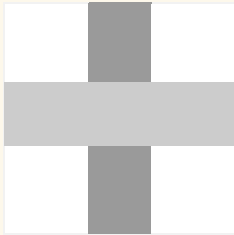

Merge on

Overlapping lines and area fills are merged.

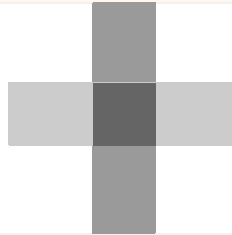

You can set the merge setting from your software in some applications. Settings in your software override the front-panel settings.



Printing Images in Grayscale

There are times when you may want to print a color image in grayscale because it is faster. Examples of this are:

- You want a draft where color is not important, for example to check that the image is not going to be clipped,
- You want a version for photocopying in black and white.

When you choose the *Ink* menu *Color settings* > *Grayscale* option the printer renders colors as Grayscale rather. If you only want to use black ink to print in grayscale, you should select the *Ink* menu *Color settings* > *True black* option.

NOTE: You cannot change the color/grayscale setting for pages already in the printer's queue.



Print Speeds and Print Quality

The following table lists some Typical Printing Times (line drawings @ 20-25°C and 30-60% relative humidity).

Typical Printing Times

Paper	Color/Grayscale	Quality	ANSI-D size	ANSI-E size
			Time (in secs)	Time (in secs)
Bright White	Color	Best	235	440
		Normal	120	225
		Draft	45	85
	Grayscale	Best	135	250
		Normal	80	150
		Draft	45	80
Coated Paper	Color	Best	490	980
		Normal	120	225
		Draft	85	160
	Grayscale	Best	325	625
		Normal	135	250
		Draft	45	80



[More Printing Times](#)



Typical Printing Times (Continued)

Paper	Color/Grayscale	Quality	ANSI-D size	ANSI-E size
			Time (in secs)	Time (in secs)
Heavy Coated Paper	Color	Best	490	980
		Normal	120	225
		Draft	85	160
	Grayscale	Best	435	870
		Normal	135	250
		Draft	45	80
Glossy Paper	Color	Best	630	1200
		Normal	435	830
		Draft	325	620
	Grayscale	Best	630	1200
		Normal	435	830
		Draft	325	620



Print Quality

You can set the overall print quality from the front panel (*Set-Up > Print Quality*).

In general choose:

- **Fast** for maximum productivity. Ideal for checking prints, when print quality is not the most important. You can reduce print speed if it is causing image quality problems with the [Fast Quality Settings](#).
- **Normal** to get a good combination of print quality and productivity. Ideal for line drawings with good print quality and at speed.
- **Best** to get the high image quality. You can increase the resolution of the Best setting with the [Best Quality Settings](#).

You can print images in different settings to see which gives the best combination of throughput and quality for your application.

See [Print Resolution](#) for information on what resolution is used with each print quality setting.



Advanced Options

Your **HP DesignJet 800PS** printer provides several advanced optimization and quality enhancement features to allow you to obtain the printed results you require.

- [Improving Line Quality and Graphics Details](#)
- [Best Quality Settings](#)
- [Fast Quality Settings](#)



Improving Line Quality and Graphics Details

The *Set-up* menu *Optimize for* option allows you to select the correct mode for the type of job you are printing. Two modes are provided: *Line drawings/text* and *Images*.

Selecting the *Line drawings/text* option smooths the fine graduations along the angles and curves of the printed image to refine the overall print quality. This enhancement produces:

- Crisper lines.
- Finer detail.
- Line drawings with a 'sharp' appearance.

The *Line drawings/text* option only affects prints that have color content.

Selecting *Line drawings/text* (the default setting) ensures you will always get the best quality color prints, except when printing the following files:

- Mixed lines and scanned color images.
- Mixed lines and color photographs.

For these files it is recommended that you select *Optimize for > Images*.



Best Quality Settings

If you have selected the Best option as the [Print Quality](#) setting for your print session but require and even higher resolution for your print job you will need to change the Best Quality Setting.

The Best Print quality option provides 600x600 dpi resolution in normal mode and 2400x1200 dpi in maximum detail mode.

NOTE: Using the maximum detail mode will improve resolution but will reduce printing speed and increase memory requirements.

Use the following procedure to increase the Best quality print resolution:

Select (using the  keys)	Then Press:
1. Set-up	Enter
2. Advanced Options	Enter
3. Best quality settings	Enter
4. Maximum detail	Enter



Fast Quality Settings

If you have selected the Fast option as the [Print Quality](#) setting for your print session and this high speed mode causes an unacceptable image quality you will need to reduce the printing speed. This can only be done from the front panel of the printer because it is not available as an option in the printer driver.

Use the following procedure to reduce the Fast print quality printing speed:

Select (using the  keys)	Then Press:
1. Set-up	Enter
2. Advanced Options	Enter
3. Fast quality settings	Enter
4. Reduced speed	Enter



Print Management

These topics describe the best methods of managing the work that the printer is doing.

- [Cancelling a Page that is Printing](#)
Shows you how to cancel a page that is currently being printed.
- [Cancelling the Drying Time](#)
Shows you how release a page from the printer before the drying time has finished.
- [Managing the Queue](#)
Details how to manage job queueing for maximum efficiency.
- [Nesting Pages](#)
Explains how to nest prints to minimize your roll media usage



Cancelling a Page that is Printing

Use the following procedure to cancel a page that is currently being printed.

1. Press Cancel on the front panel.

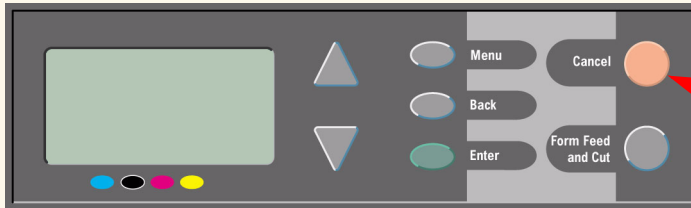

Cancel Key

The printer advances the paper as though the print were finished. A multi-page job or a big file may take longer to stop printing than other files.



Cancelling the Drying Time

CAUTION: Use caution when performing this procedure as an image which has had insufficient time to dry could get damaged.

Use the following procedure to cancel the drying time for the job waiting for the end of drying time.

1. Press Cancel or Form Feed & Cut on the front panel.

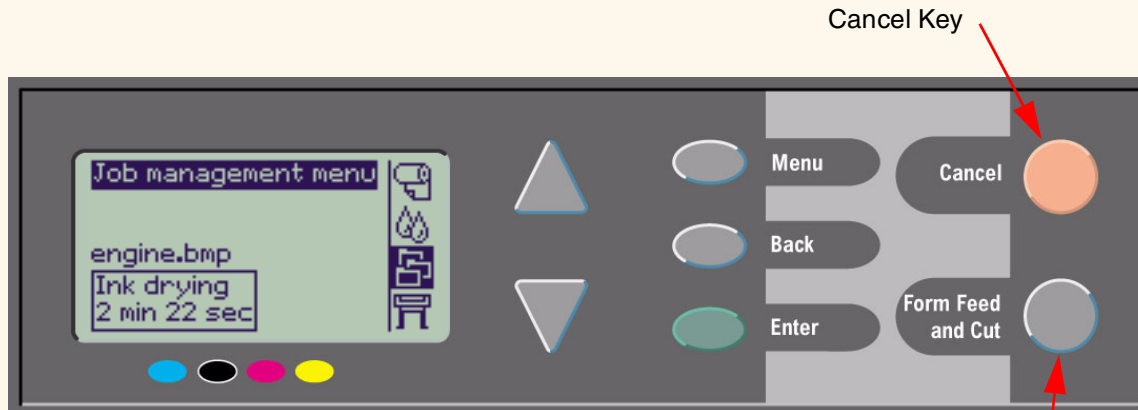

Cancel Key

Form Feed & Cut Key

The printer will release the printer and it will fall into the paper bin.

Managing the Queue

These topics explain how the queueing function operates and how to use to manage your print jobs.

- [What is the Queue?](#)
- [Printing with Queueing Turned ON](#)
- [Printing with Queueing Turned OFF](#)
- [Starting to Print a File that is Waiting for a Time-out](#)
- [Identifying a Job in the Queue](#)
- [Prioritizing a Job in the Queue](#)
- [Prioritizing a Job in the Queue](#)
- [Making Copies of a Job in the Queue](#)



What is the Queue?

Your printer can store pages in a queue at the same time as printing the current page. It stores them page by page. If you send only a single-page, you can regard these as files.

The size of the queue is limited by number of jobs (maximum of 32 jobs) and the total memory available.

The queue stores processed output pages, not the input jobs.

NOTE: If you send a very complex PostScript job with Queueing Off, the printer may stop during printing of the image while it is processing the job. This may result in an image quality defect. To avoid this, always print very complex files with Queueing On.

When Queueing is On and the printer receives print files, the files are stored in the queue in the order they are received. If Nesting is Off (the default), the files are printed as soon as possible, in the order they are received. If Nesting is On, files are printed when the time-out period expires or there are enough files to fill a page width. You can re-send files which have already been printed.



Printing with Queueing Turned ON

- You can send pages to the printer without waiting for the current page to finish printing.
- Pages are stored in the queue in the order they are received.
- You can manipulate the pages in the queue, for example prioritizing them and reprinting them.
- You can use nesting, the printer's paper-saving feature (see [Nesting Pages](#)).
- While one page is printing, the printer will accept and process the next file.



Printing with Queueing Turned OFF

If Queueing is Off and the printer receives print files, the files are printed as they are received, and are not stored in the queue. Nesting settings have no effect when Queueing is Off.

- Files are printed as they are received, and are not stored in the queue.
- The printer will not accept another file sent from the computer until the current page has finished printing and the printer is ready.
- You cannot use nesting.

If you turn queueing off while pages are still in the queue, they will be printed and (if nesting is on) nested, until the queue is empty.

NOTE: If the printer is turned off with files in the queue that have not been printed, the files are lost and must be resent.



Starting to Print a File that is Waiting for a Time-out

If all is in order (paper loaded, all ink components installed, and no file errors), there are still reasons why a file you have sent from your computer may not start printing when expected:

- The print file may lack a proper file terminator and the printer is therefore waiting for the specified I/O time-out period before assuming it is complete. See [To Change the I/O Time-out Setting](#).
- Nesting may be on and the printer is waiting for the specified nest wait time-out period before calculating the appropriate nests. In this case, the printer display shows the remaining time for the nesting time-out. See [How Long does the Printer Wait for Another File?](#).
- If your file has selected sheet or roll paper to print the job onto, but the selected paper is not loaded into the printer:
 - the front panel will prompt you to load the selected paper, once you load the paper the printer will print the job.
 - Press the **Cancel** key and re-send the job with paper that you have available.

If you want to override the time-out period and start printing, press Form Feed and Cut on the front panel.

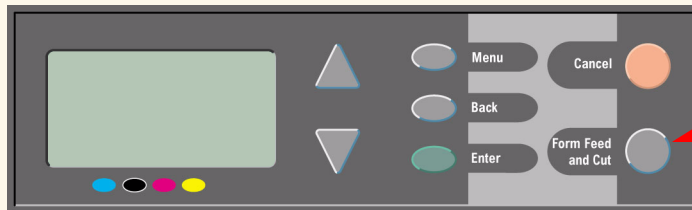

Form Feed
and Cut Key



Identifying a Job in the Queue

In Queueing & Nesting, you can scroll through the pages in the queue.

The queue positioning operates as follows:

- The job currently being printed is in position 0.
- The next job to be printed is in position 1.
- The one after in position 2, etc. ...
- The previous job printed is in position -1
- The one before that in position -2, etc. ...

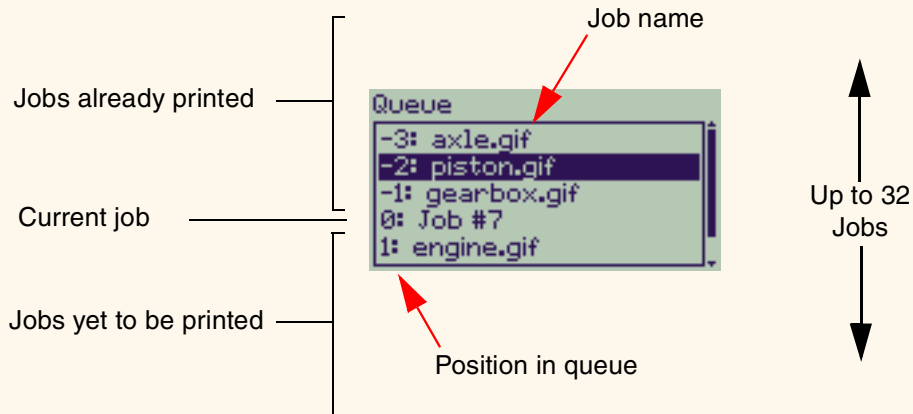

Prioritizing a Job in the Queue

To make any job in the queue the next one to be printed, highlight it in the queue and press **Enter**. Then you mesu choose Move to top menu option to the job the next one to be printed.

If nesting is turned on (see page [What is Nesting?](#)) the prioritized job may still be nested with others. If you really want this job to be printed without nesting, then first turn nesting off and then use **Move to top** to make it next job in the queue.

Deleting a Job from the Queue

Under normal circumstances, there is no need to delete a job from the queue after printing it, as it will just “fall off the end” of the queue as more files are sent. However, if you have sent a file in error and want to avoid any chance of it being reprinted, you can simply delete it, by selecting it and choosing Delete.

To remove a job that has not yet been printed, simply identify it by its position in the queue (see [Prioritizing a Job in the Queue](#)) and delete it, by choosing Delete.

If the job is currently being printed (its queue position is 0), and you want both to cancel the job and to delete it, first press the Cancel key and then delete it from the queue.



Making Copies of a Job in the Queue

Has the job already been printed?	Do you want one copy or several?	What to do
Yes	One	Use Move to top (see Prioritizing a Job in the Queue).
	Several	Use Reprints (see below) and then use Move to top (see Prioritizing a Job in the Queue).
No	One or Several	Use Copies (see below).

In all cases, the job must still be in the queue. Use the following procedure to make copies of a job in the queue:

NOTE: The setting you specify in this option overrides any value set by your software.

NOTE: If Rotate (see page [Rotating an Image](#)) was on when you sent the file, every copy will also be rotated.

Copies and Reprints

1. Select the job and choose Copies or Reprints (from the Job Management menu).
2. Use the scrolling keys to specify the number of copies required and press Enter.
The number you enter is the actual number of pages to be printed; for example, choosing 2 for a page not yet printed means you will get the one original and one copy. The maximum is 99.

If you want to cancel a Copies or Reprints selection choose the Cancel menu option for the file you have selected to print copies or reprints.



Nesting Pages

- [What is Nesting?](#)
- [When Does the Printer Try to Nest Pages?](#)
- [Which Pages Qualify for Nesting?](#)
- [Turning Nesting On and Off](#)
- [What Happens to Nesting if You Turn Queueing Off?](#)
- [How Long does the Printer Wait for Another File?](#)



What is Nesting?

Nesting means placing pages side-by-side on the paper (rather than one after the other), to avoid wasting paper.

NOTE: Nesting can only be used with roll media.

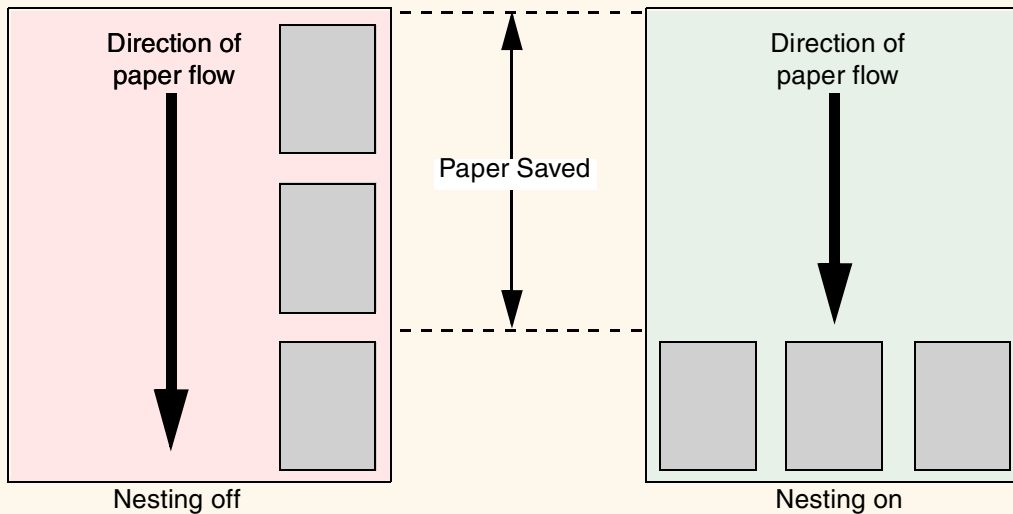

When Does the Printer Try to Nest Pages?

When all the following are true:

- The printer is loaded with roll paper rather than sheet paper.
- In the front-panel menus, Queue is ON (the default). See page [What is the Queue?](#)
- In the front-panel menus, Nest is ON. See page [Turning Nesting On and Off.](#)

Which Pages Qualify for Nesting?

In order to be in the same nest, the individual pages must be compatible on the following criteria:

- Color or grayscale.

NOTE: Either all are color or all are grayscale.

- Files must be at the same dots per inch setting.
- All pages must have the same print quality setting (Best, Normal, Draft).
- Margin sizes must be the same for all pages (normal or extended).
- All pages must be the same graphics language.
- Equal mirror setting



Turning Nesting On and Off

To enable or disable nesting, select Nest from the Job Management menu and choose On or Off.

- On The printer will search all through the queue for suitable pages. It will nest the pages according to an algorithm that, for most combinations of page sizes, saves the most paper. The resulting nesting pattern may still vary, depending on the size of the first page.
- Off The printer will not nest pages.



What Happens to Nesting if You Turn Queueing Off?

Turning queueing off does not turn nesting off for pages already in the queue. The printer prints all the pages in the queue before accepting any more files. As soon as you turn queueing off, the nesting setting also changes to off. When queueing is turned on again, the printer restores nesting to its previous setting.

How Long does the Printer Wait for Another File?

So that the printer can make the best nest possible, it waits after a file has been received to check if a subsequent page will nest with it or with pages already in the queue. This waiting period is the nest wait time factory default nest wait time is two minutes. This means that the printer waits for up to two minutes after the last file is received before printing the final nest. You can change this waiting time using the front panel menu. The available range is 1 to 99 minutes.

While the printer is waiting for nesting to time out, it displays the remaining time in the front-panel display. You can print the nest (cancel the nest wait) by pressing the Form Feed and Cut key.



Printer Configuration

These topics explain how to change the configuration of your printer.

- [Printer Information](#)
- [Front Panel Setup](#)
- [Altitude Setting](#)
- [Changing the Graphics Language](#)
- [Graphics Language and Networks](#)
- [Setting up the I/O Card](#)
- [Controlling the Cutter](#)
- [Upgrading Your Printer](#)
- [Color Settings](#)
- [Postscript Encoding](#)
- [Logs](#)



Printer Information

Your **HP DesignJet 800PS** printer provides an information display on the front panel that shows the current configuration of the system. You can also print out this information directly on your printer.

Select Set-up > *Printer information* > *View* to view the information or *Printer information* > *Print* to print it.

The printer information screen shows the following information about your printer:

- Model Number
- Serial Number
- Service ID
- Firmware Rev.
- Accessory Rev.
- Paper Used
- Ink used (C, M, Y, K)
- Scan Axis Usage
- Paper Axis Usage
- Service Station Usage
- Spittoon Usage
- Pinch Lift Usage
- Cutter usage
- Ink Usage



Front Panel Setup

You can configure the following parameters for the front panel:

- [Menu and Message Language](#)
- [Alert Buzzer](#)
- [Screen Contrast](#)



Menu and Message Language

The following languages can be used for all menus and messages shown on the front panel of your **HP DesignJet 800PS** printer:

- English
- German
- Spanish
- French
- Italian
- Japanese
- Portuguese
- Korean
- Simplified Chinese
- Traditional Chinese

To change the language:

1. Select the *Front Panel > Language* option from the Set-up menu.
2. To scroll to the language you require and press **Enter**.



Alert Buzzer

Your **HP DesignJet 800PS** printer is equipped with an alert buzzer that is used to warn you when:

- A task has completed.
- An error has been detected.
- You change a parameter from the front panel.

To enable or disable the buzzer:

1. Select the *Front Panel* > *Buzzer* option from the Set-up menu.
2. Highlight Buzzer = ON or Buzzer = OFF (whichever is displayed) and press **Enter**.
3. Scroll to the option you require, ON or OFF, and press **Enter**.



Screen Contrast

You can adjust the screen contrast of the front panel to best suit the ambient lighting conditions at your location. The contrast can be varied from 0% to 100% in 5% increments. The default setting is 50% and is suitable for most situations.

To adjust the screen contrast:

1. Select the *Front Panel* > *Contrast* option from the Set-up menu.

NOTE: Any value below 20% shows a blank screen and any value over 80% shows a black screen.

2. Scroll to the required value and press **Enter**.



Altitude Setting

Your **HP DesignJet 800PS** printer contains a vacuum pump which is used to hold media on the platen. The altitude of your location effects the efficiency of this pump so you need to specify the altitude to ensure the pump operates correctly.

To set the altitude:

1. Select the *Altitude* option from the Set-up menu.
2. Scroll to the required value (0 - 1000m, 1000m to 2000m or > 2000m) and press **Enter**.

The following table shows the corresponding altitude values in feet.

Meters	Feet
0 -1000	0 - 3300
1000 - 2000	3300 - 6600
> 2000	>6600



Changing the Graphics Language

Your software application uses a graphics language to communicate with the printer. The printer's default language setting is called Automatic and works for most software applications.

In Automatic mode, the printer determines which type of file it is receiving i.e. PostScript or HP-GL/2, and prints it. Unless you are experiencing printing problems you should not need to change this default.

See [To Change the Graphics Language Setting](#) to modify this setting.



To Change the Graphics Language Setting

To change the graphics language setting, go to the Setup/Graphic Language menu. The following selections are available:

Graphics Language Settings

Language	Comments
Automatic	Choose Automatic to let the printer determine which type of file it is receiving. This setting works for most software applications.
PostScript	Choose PostScript if you are printing only PostScript files and your PostScript jobs do not include PJP language switching commands.
HP-GL/2	Choose this setting if you are not working with PostScript files and: <ul style="list-style-type: none"> • you have experienced image position problems. • you have experienced timing problems.
CALS G4	Choose this setting if your files are in the CALS G4 language. This must be selected because the Automatic setting is not sufficient. If you select the CALS G4 setting to print a CALS file, the printer must be returned to the default setting afterwards to enable printing in other languages.



Graphics Language and Networks

For system administrators

If you are using the printer with a network spooler, consider having your system administrator modify the spooler to insert automatically the [PJL](#) language-switching commands at the beginning and end of each file. This allows the printer to switch automatically into the correct graphics language for your current print and returns the printer to the front-panel [graphics language](#) setting for subsequent prints.

For information on ordering PJL reference information, see [Ordering Accessories](#).

The HP PostScript printer driver for Windows provided with your printer, adds the PJL language-switching commands to your output file, allowing the printer to switch graphics languages automatically.



Setting up the I/O Card

Network

With a network interface (such as the HP JetDirect Print Server), refer to your network interface documentation for advice on any front-panel configuration. The front-panel menu is I/O Setup > Card Set-up.

To Change the I/O Time-out Setting

Some software applications do not write a file terminator at the end of a file. In this case, the printer does not know when the file is complete and will wait for more data until the end of the “I/O Time-out” period. By default, this period is 30 minutes. You can change the time-out setting in the front-panel menu (Set-Up > I/O setup > I/O Timeout) to as little as 30 seconds.



Controlling the Cutter

With roll media loaded when any print job you have send to the printer completes the roll is automatically cut and the print job falls into the media bin. There may be a delay before the roll is cut due to the drying time you have prograded or the printer has automatically selected.

In some situations you may not wish to cut the roll after each print job. Use the following procedure to control the cutter. The front panel menu selections are:

Select (using the  keys)	Then Press:
1. Paper menu	Enter
2. Cutter	Enter
3. ON or OFF	Enter



Upgrading Your Printer

System Software

“System Software” is the name given to a type of software which runs the functions in your printer.

System Software downloading

From time to time there will be system software upgrades available from Hewlett-Packard. System software upgrades increase your printers functionality and enhances the features that your printer already possesses. System software can be downloaded from the Internet.

For the latest upgrades, go to <http://www.hp.com/go/designjet>. Follow the on-screen directions.



Color Settings

Your printer can emulate the color behavior of offset printing presses, allowing you to use your printer for color proofing. To get accurate colors for your proof, select the color emulation mode that matches your offset printing standards from the Ink menu Color settings option. The selections are:

Color/monochrome

Refer to [Printing Images in Grayscale](#) for further details

- Color - the printer prints in color
- Grayscale - the printer prints the color image in grey shades.
- True black - the printer prints the color image in grey shades using black ink only.

RGB

- Native/Device RGB - No ink emulation
- sRGB - Standard RGB

CMYK

- Native/Device CMYK - No ink emulation
- SWOP - U.S. Specification for Web Offset Printing
- EuroScale - European standard for offset press.
- TOYO - Japanese standard for offset press
- DIC - Dainippon Ink and Chemicals, Inc.

[Rendering Intent](#)

- Perceptual
- Saturation
- Colorimetric



Postscript Encoding

Your printer provides a manual method of selecting the type of file encoding for Postscript files. Normally you should never need to change the default Automatic encoding which detects the type of file encoding when the printer receives the file.

There are however rare cases caused by combinations of applications and third party drives that produce Postscript files that the printer cannot automatically detect what type of encoding has been used. Whenever this happens the printer will display a error message on the front panel.

To print the file you must first check what type of encoding has been selected with your driver and then make the corresponding selection with the *Set-Up* menu *PS settings* option. In addition to Automatic encoding two other encoding types are available: ASCII and Binary.



Logs

Your **HP DesignJet 800PS** printer keeps a log for the printheads and an error log. These logs are normally used by service engineers.

Printhead Log

The printhead log contains a list of the last five printheads of each color along with information about the usage of the printhead.

Error Log

Lists the last errors detected the printer has detected along with the date the error occurred and a unique error code for the type of error detected.



Other

The Other tab provides miscellaneous procedures and information that may be required to ensure your printer remains in a fully operational condition at all times.

The Other tab contains these sections:

- [Care of the Printer](#)
- [Installing Expansion Cards](#)
- [Specifications](#)
- [Ordering Accessories](#)
- [Glossary](#)



Care of the Printer

This section contains information on general maintenance of the printer.

- [Cleaning the Printer](#)
Instructions for cleaning the exterior of your printer.
- [Storing and Moving Your Printer](#)
Instructions on how to move and store your printer.



Cleaning the Printer

WARNING: To avoid an electric shock, make sure that the printer is switched OFF and disconnected from the mains supply before you clean it. Do not let water get inside the printer.

CAUTION: Do not use abrasive cleaners on the printer.

NOTE: Any maintenance or repairs beyond those described in this chapter should be done by a qualified service technician.

Cleaning the Printer Exterior

Clean the outside of the printer as required with a damp sponge or a soft cloth and a mild household cleaner such as non-abrasive liquid soap.



Storing and Moving Your Printer

If you need to move your printer or store it for an extended period of time, you need to prepare your printer properly to avoid possible damage to the printer. To prepare your printer, follow the instructions given below:

CAUTION: It is important that you do not remove the Ink Cartridges and Printheads before moving or storing the printer.

1. Switch the power off at the On/Off power switch on the front of the printer.
2. Disconnect any cables connected to the printer; parallel interface, LAN connection.
3. Repack the printer in its original packaging. Refer to Assembly/Repacking Instructions booklet supplied with the printer for details.
4. If you have to move your printer you will need the original packaging. If necessary you can order a kit of the packaging materials. Contact HP support and they will supply it to you. If necessary they will repackage the printer for you.



Installing Expansion Cards

The following options are available for your **HP DesignJet 800PS** printer:

- [Network Card Installation](#)



Network Card Installation

An HP JetDirect Network Card is installed in your printer when you buy it. If you wish to use a different network card install it using the following procedure.

HP JetDirect Network Card Installation

1. Before installing a card, switch off the printer and unplug it from the mains electricity supply.

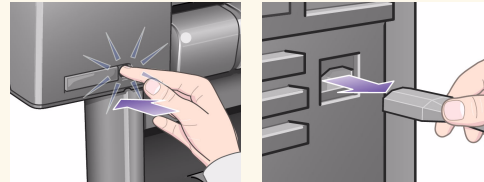

2. Carefully remove the plastic cover from the left-hand back of the printer by unclipping it. This cover gives access to the two slots for an Accessory card and a LAN card.

- Press in the thumb-tab on the side furthest from the edge that has the cable-hole.
- Ease the cover out in the direction of the embossed arrow, pivoting it by the hinge clips on the side that has the edge cable-hole.

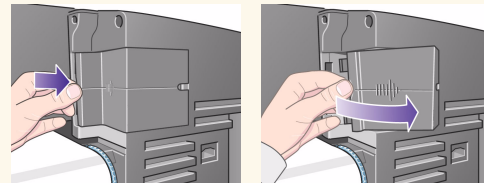

[Continued ...](#)



HP JetDirect Network Card Installation (Continued)

3. Remove the cover completely. Inside the compartment there are two slots for a LAN card or an Accessory card.

You can use either slot for either card, but we recommend putting a LAN card on the left (nearer to the front of the printer) and an Accessory card on the right. In this way the cable from the LAN card can easily pass through the slot in the door.

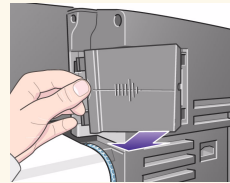

4. To insert a LAN card (or an Accessory card), remove the metal cover from the appropriate slot by unscrewing its two screws. You can use a screwdriver or do it manually.

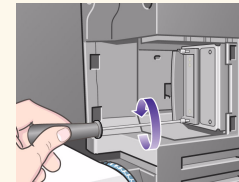
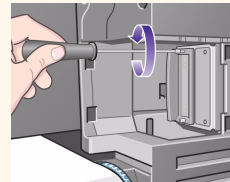

5. When you have inserted the card, screw it into place, using its two screws (at the top and bottom of the card). Again, this can be done with a screwdriver or manually.

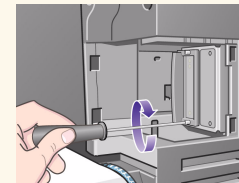
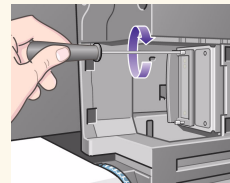

[Previous ...](#)

[Continued ...](#)



HP JetDirect Network Card Installation (Continued)

6. Insert the LAN cable into the LAN card. It is simply pushed into place and clicks when locked.

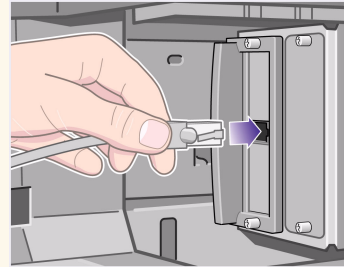

7. Carefully replace the plastic cover by clipping it back into place:
- Put the two hinge clips on the side that has the edge cable-hole into their slots.
 - Swivel the cover in the direction opposite to the embossed arrow and clip the other two tabs on the opposite side into their slots. Ensure that the LAN cable passes correctly through the edge cable-hole (shown by the yellow arrow).
 - Take care to carefully route the LAN cable so it does not interfere with the spindle or roll.

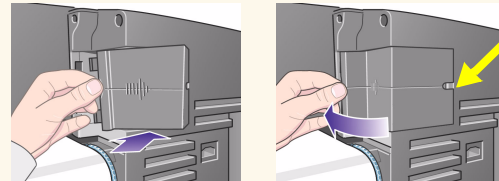

8. Once you have completed the physical installation of the card you will have to configure it for you LAN, see [Setting up the I/O Card](#).

[Previous ...](#)



HP-GL2 Accessory Card Installation

Not available for your printer model.



Specifications

- [Functional Specifications](#)
- [Memory Specifications](#)
- [Printer Power Specifications](#)
- [Ecological Specifications](#)
- [Enviromental Specifications](#)
- [Acoustic Specifications](#)
- [Connection Specifications](#)



Functional Specifications

HP DesignJet 800PS Functional Specifications

Functional Specifications				
HP Ink Supplies Supplies	Four colors: cyan, magenta, yellow and black.			
	Printheads:	600 dpi,	36 kHz (Cyan, Magenta, Yellow). 36 kHz (Black).	
	Ink Cartridges contents:		Cyan	69 ml
			Magenta	
Yellow				
Black				
Paper sizes	Width (carriage axis)		Length (paper axis)	
	Minimum	Maximum	Minimum	Maximum
Roll - D/A1 size printer	140 mm 5.5 inches	625 mm 25 inches	1000 mm 40 inches	100 mm 4 inches roll external diameter
Roll - A0+/ E+ size printer		1071.8 mm 42.2 inches		
Sheet -D/ A1 size printer		625 mm 25 inches	140 mm 5.5 inches	1897 mm 74.7 inches
Sheet -A0+/ E+ size printer		1071.8 mm 42.2 inches		

[More ...](#)



HP DesignJet 800PS Functional Specifications (Continued)

Functional Specifications

HP Supported Media^a

HP Bright White Inkjet Paper (Bond)

HP Vellum

HP Natural Tracing Paper

HP Coated Paper

HP Heavyweight Coated Paper

HP Matte film

HP High-Gloss Photo Paper

HP Semi-Gloss Photo Paper

HP Paper-Based Semi-Gloss

HP Clear film

HP Translucent bond

HP Studio Canvas

HP Satin Poster Paper

HP Banners with Tyvek®

HP Colorfast Adhesive Vinyl

[Previous ...](#)

[More ...](#)



HP DesignJet 800PS Functional Specifications (Continued)

Functional Specifications				
Resolution	Print Mode		Line drawing/text	Image
	Fast	Render		300x300dpi
Halftone			600x300 dpi	600x300 dpi
Normal	Render		600x600 dpi	300x300 dpi
		Halftone	600x600 dpi	600x300 dpi
Best (default)	Render		600x600 dpi	600x600 dpi
		Halftone	600x600 dpi	600x600 dpi
Best (maximum detail)	Render		600x600 dpi	1200x1200 dpi
		Halftone	1200x600 dpi	2400x1200 ^b dpi

[Previous ...](#)

[More ...](#)



HP DesignJet 800PS Functional Specifications (Continued)

Functional Specifications				
Margins	Roll (normal)	Sheet (normal)	Roll (small)	Sheet (small)
	Side Margins 5 mm Leading Edge Margin 17 mm Trailing Edge Margin 17 mm			
Graphics languages supported	HP-GL/2 HP-RTL CALRASTER Adobe PostScript 3 (supports Asian fonts)			
Accuracy	0.2% of the specified vector length at 23° (73°F), 50-60% Relative Humidity, on HP special polyester film.			

[Previous ...](#)

- a. From time to time, new paper types may become available. For up-to-date information, please contact your HP dealer or our web site www.designjet-online.hp.com.
- b. Glossy Photo Media Only



Physical Specifications

Physical Specifications				
Type	Weight	Width	Depth	Height
D/A1 size printer	38.5 kg 85 lb	1253 mm 49 inches	470 mm 19 inches	349 mm 14 inches
A0+/E+ size printer	45 kg 99 lb	1690 mm 67 inches	674 mm 27 inches	1100 mm 43 inches



Memory Specifications

Memory Specifications	
Internal RAM	160MB
Hard Disk	6 GB



Printer Power Specifications

Printer Power Specifications	
Source	100-240 V AC \pm 10% auto-ranging
Frequency	50/60 Hz
Current	3 amp maximum
Consumption	150 watts maximum



Ecological Specifications

Ecological Specifications	
Energy efficiency	Compliant with Energy Star Program EPA (US).
Manufacturing process	Free of ozone-depleting chemicals (Montreal Protocol).
Plastics	Free of brominated flame retardants (PBB and PBDE). All housing parts made of the same material: ABS. Parts marked according to ISO 11469 standard.
Metals	Enclosures made of electro-galvanized steel sheet.
Packaging	Cardboard (non-chlorine-bleached) and foam are 100% recyclable. Inks used for printing do not contain heavy metals.
User Documentation	Majority provided in Adobe Acrobat PDF format on CD-ROM
Batteries	Not used.
Recyclability	Modular construction, screws easy to find and disassembly done using universal tools.



Environmental Specifications

Environmental Specifications		
Operating Ranges	Printing:	15°C to 35°C (59° F to 95° F) RH 20% to 70%.
	Optimal print quality for HP glossy media:	15°C to 30°C (59° F to 86° F) RH 20% to 80%.
	Optimal print quality for other HP media:	15°C to 35°C (59° F to 95° F) RH 20% to 70%.
Non Operating Ranges	Printer:	-40°C to 70°C (-40° F to 158° F)
	Packed consumable items and system:	-40°C to 60°C (-40° F to 140° F)

NOTE: At altitudes greater than 3000m the printer may have operational problems.



Acoustic Specifications

Acoustic Specifications	
Operating sound pressure	54 dB (From a one-meter bystander position)
Idle sound pressure	<30dB (A) (From a one-meter bystander position)
Operating sound power	6.5 Bels (A)
Idle sound power	<4.3 Bels (A)



Connection Specifications

- [Cable Specification](#)
- [Recommended Cables](#)



Cable Specification

The connector on the printer is 36-pin female connector. Most existing parallel cables support IEEE-1284 compatible communication, but for use with this printer, the cable must meet the specifications in the following table:

Parallel (IEEE-1284 compatible/ Centronics) Interface		
Pin	Wire/Signal Name	Source
1	Strobe	computer
2 ... 9	D0 ... D7 (data lines)	both
10	Ack	printer
11	Busy	printer
12	PError	printer
13	Select (SelectOut)	printer
14	AutoFd	computer
16	GND	
19 ... 30	GND	
31	Init	computer
32	Fault	printer
36	SelectIn	computer



Recommended Cables

The following cable is recommended for optimum performance and electromagnetic compatibility:

Recommended Cable			
Interface type (Computer)	HP part number	Cable length	Connector type at computer end of cable
IEEE compatible/Centronics Interface (All)	C2951A	3.0 m	25-pin male
USB	C2392A	5.0 m	USB plug



Ordering Accessories

You can order supplies and accessories in any of the following ways:

- Call your local authorized HP dealer.
- Contact your local HP Sales and Support office.
- Refer to the **Hewlett-Packard Support / Services** booklet that was supplied with your printer.
 - [Documentation](#)
 - [Hardware](#)
 - [Consumable Items](#)



Documentation

Language	Pocket Guide	User's Reference Guide	Unpacking and Assembly poster
	HP Part Numbers		
Chinese	C7769-90020	C7769-90131	C7769-90040
Czech	C7769-90021	Not available	Not available
English	C7769-90011	C7769-90131	C7769-90031
French	C7769-90015	C7769-90135	C7769-90035
German	C7769-90014	C7769-90134	C7769-90034
Greek	C7769-90022	Not available	Not available
Hungarian	C7769-90023	Not available	Not available
Italian	C7769-90017	C7769-90137	C7769-90037
Japanese	C7769-90018	C7769-90138	C7769-90038
Korean	C7769-90012	C7769-90132	C7769-90032
Lithuanian	C7769-90029	Not available	Not available
Polish	C7769-90024	Not available	Not available
Portuguese	C7769-90019	C7769-90139	C7769-90039
Russian	C7769-90025	Not available	Not available
Spanish	C7769-90016	C7769-90136	C7769-90036

[Next](#)



Language	Pocket Guide	User's Reference Guide	Unpacking and Assembly poster
	HP Part Numbers		
Slovakian	C7769-90030	Not available	Not available
Taiwanese	C7769-90013	C7769-90013	C7769-90033
Thai	C7769-90026	Not available	Not available
Turkish	C7769-90027	Not available	Not available

[Previous](#)

Hardware

Item		HP Part Number
JetDirect EIO Network Cards	10Base-T	J3110A
	10 Base2, 10-T	J3111A
	LocalTalk	J3112A
	Token Ring 10/100Base-TX	J4169A
Spindle	610 mm - 24 inch	C2388A
	1067 mm - 42 inch	C2389A
Stand 610 mm - 24 inch	FL for 500 series	C7782A
	GR for 800 series	C7781A



Consumable Items

Item	Color	HP Supply No.	HP Part Number
Ink Cartridges	Black	10	C4844A
	Cyan	82	C4911A
	Yellow		C4913A
	Magenta		C4912A
Printheads	Black	11	C4810A
	Cyan		C4811A
	Yellow		C4813A
	Magenta		C4812A

To achieve the best performance from your printer, we recommend you only use genuine Hewlett-Packard accessories and supplies, whose reliability and performance have been thoroughly tested to give trouble-free performance.





Glossary

Term	Meaning
ANSI paper	An American standard paper size; e.g. D, E.
Architectural paper	The Architectural paper sizing system
application	The software you use to create your drawings.
Centronics	A standard for the parallel interface between computer and device.
clipping	Losing part of a drawing at the edges.
CMP	Complementary Media Program that helps HP customers grow their businesses by referencing third-party printing material choices to ensure maximum HP DesignJet printer flexibility and printing solutions.
CMYK	Cyan, magenta, yellow and black. The colors of the printer's four inks, and also a standard color model.
Coated paper	Paper coated on one side for inkjet printing.
default	A value or condition that is assumed if no other value or condition is specified.
device	An external item connected to the computer: printer, tape drive, etc. Your HP DesignJet is a device.
dpi	Dots per inch, a measure of print resolution.
drivers	Software that controls the communication between a computer and a device.
front panel	The control panel on the front right of the printer.

For More Terms, click on the Next Page Icon



**Term****Meaning**

front panel menus	The structure of options in the front-panel display.
graphics language	A programming language telling a print device how to output graphic data.
grayscale	Shades of gray to represent colors.
high-gloss photo	A glossy, opaque photographic paper.
HP-GL/2	One of Hewlett-Packard's standard graphics languages for plotters and printers. Produces vector data.
ICC Profile	An International Color Consortium Device Profile.
I/O Input/output	The transmission of data between a computer and a device.
IEEE-1284	A standard issued by the Institute of Electrical and Electronics Engineers (IEEE) as the Standard Signaling Method for a Bi-directional Parallel Peripheral Interface for Personal Computers
ink cartridge	The part of the HP Ink Supplies which contains all the ink used in the printer. They are installed into the printer on the right side.
inked area	The smallest rectangle that contains all the content of the drawing, while maintaining its relative dimensions.
ISO paper	An international standard paper size; e.g. A1, A2, etc.

For More Terms, click on the Next Page Icon



**Term****Meaning**

JIS	A Japanese standard paper size.
LAN	Local area network.
long-axis printing	Printing a page when the length is longer than a standard page size.
margin	The space around the page added by the printer to separate one page from another and to avoid printing right to the edge of the paper.
Nesting	Placing two or more pages side-by-side on roll paper to avoid waste.
nozzles	Located underneath the printhead. The nozzles direct the ink onto the page.
palette	A set of logical pens defined by color and width.
PJL	Printer Job Language. A programming language that controls jobs going to a printer.
parallel interface	A type of interface between computer and device. Generally faster than a serial interface.
PANTONE	The PANTONE MATCHING SYSTEM® is an international standard for color communication in the graphics art industry.
pen	Even though the printer has no physical pens, the lines it draws match the attributes of a pen.
platen	The exterior part of the printer on which the paper rests before going into the printer.

For More Terms, click on the Next Page Icon



**Term****Meaning**

printhead	The printhead is installed into the carriage assembly. It is the part which prints the ink onto the paper.
printing area	Page size minus margins.
PostScript	Adobe PostScript is a computer language that describes the appearance of a page, including elements such as text, graphics, and scanned images, to a printer or other output device.
queueing	Placing each print received by the device into memory for processing with other prints.
raster	A method for defining an image, in terms of dots rather than lines. Raster data typically needs more memory than vector data.
Rendering Intent	<p>Rendering intent is a concept defined by ICC Spec ICC.1:1998-09, "File Format for Color Profiles".</p> <p>From the specification: "Rendering intent specifies the style of reproduction to be used during the evaluation of this profile in a sequence of profiles. It applies specifically to that profile in the sequence and not to the entire sequence. Typically, the user or application will set the rendering intent dynamically at runtime or embedding time."</p>
RGB	Red, green and blue. A standard color model.
RIP	Raster Image Processor.
RTL	Raster Transfer Language (RTL) is one of Hewlett-Packard's standard graphics languages for plotters and printers. Produces raster data.

For More Terms, click on the Next Page Icon



**Term****Meaning**









spindle	The rod which holds the roll of paper.
paper-axis	The vertical axis, as you look at the printer from the front in which the paper feed moves.
scan-axis	The horizontal axis, as you look at the printer from the front in which the print carriage moves.
service station	The part of the printer which services the printheads. It keeps the printheads clean and stops them from drying out.
USB	Universal Serial Bus









A B C D E F G H I J K L M N O P Q R S T U V W X Y Z

Index







A























accuracy calibration 
 acoustic specifications 
 Action Keys 
 adjusting page size 
 Adjusting the Page Size in the Front Panel 
 Advanced Calibration 
 Aligning Printhead 
 ANSI Paper 
 Architectural Paper 

B



Back Key 
 Banding 
 Best 
 Print Resolution 
 Blurred Lines 
 bright white inkjet paper 

C

cable specifications 
 cables
 interface 
 parallel 
 Calibration 
 Cancel Key 
 Cancel Print 
 Cancelling Drying Time 

cancelling the drying time 
 canvas 
 choosing media 
 clear film 
 Clearing Media Jam 
 Clipped Images 
 clipped images 
 coated paper 
 Color Accuracy
 Configuration 
 Additional Information 
 Problems 
 Settings 
 Media 
 Color Alignment Problems 
 Color Consistency Problems 
 colors
 internal palettes 
 Communications Problems 
 Component Identification 
 connections 
 controlling image quality 
 Correcting the Printer Configuration 
 Cutter Replacement 

D

Display Screen 
 Dots per inch
 Draft 



A B C D E F G H I J K L M N O P Q R S T U V W X Y Z

double sided paper 

Down Key 

drivers 

Drying Time 

 Cancelling 

 Procedure 

 Settings

 Automatic 

 Manual 

 None 

 Typical 

E

ecological specifications 

Enter Key 

environmental specifications 

F

Fast

 Print Resolution 

Finding the Source of a Problem 

Fit To Page 

Form Feed & Cut Key 

Front Panel

 Action Keys 

 Display Screen 

 Introduction 

 Menu Structure 

 Navigation Keys 

 Page Size Setting 

functional specifications 

G

graphics language

 changing 

graphics language and networks 

H

Handling Media 

hard drive upgrade 

heavy coated paper 

high-gloss photo 

HP Ink Supplies 

 HP No 10 

 HP No 11 

 HP No 82 

 Ink cartridges 

 ink cartridges 

 Printheads 

 printheads 

 When to Replace 

I

I/O time-out setting

 changing 

Identifying a Job in a Queue 

Identifying Components 

Image Appearance 

Image Clipping 

Image Error

 Image is Clipped 



[A](#) [B](#) [C](#) [D](#) [E](#) [F](#) [G](#) [H](#) [I](#) [J](#) [K](#) [L](#) [M](#) [N](#) [O](#) [P](#) [Q](#) [R](#) [S](#) [T](#) [U](#) [V](#) [W](#) [X](#) [Y](#) [Z](#)

[Long-Axis Image is Clipped](#)
[Output Contains Only a Partial Print](#)
[Print is Blank](#)

[Image is Clipped](#)
[Image is Unexpectedly Rotated](#)
[Image Quality Problems](#)
[image quality controlling](#)
[Image Rotation](#)
[Page Size](#)
[PostScript Files](#)
[Third Party PostScript Drivers](#)
[What is Rotated](#)

[Incomplete Lines Problems](#)
[Information](#)
[Roll Media](#)
[Sheet Media](#)

[Ink System](#)
[Precautions](#)

[Ink Bleeds](#)
[Ink Cartridge](#)
[Problem Inserting](#)
[Replacement](#)
[Statistics](#)

[Ink cartridges](#)
[HP Ink Supplies](#)
[ink cartridges](#)

[HP Ink Supplies](#)
[ink emulation mode selecting](#)
[Ink Menu](#)
[Ink Supplies. See HP Ink Supplies](#)
[Ink Supply Problems](#)
[Ink System](#)

[Cartridge](#)
[Replacement](#)
[Statistics](#)
[Drying Time](#)
[Automatic](#)
[Manual](#)
[None](#)

[Printhead](#)
[Alignment](#)
[Replacement](#)
[Statistics](#)

[Inked Area](#)
[inked area](#)
[Installing](#)
[Roll Media](#)
[interface cables](#)
[interface specifications](#)
[interfaces](#)

[Fast Ethernet 10/100 base TX](#)
[parallel](#)
[USB](#)
[internal palettes](#)



[A](#) [B](#) [C](#) [D](#) [E](#) [F](#) [G](#) [H](#) [I](#) [J](#) [K](#) [L](#) [M](#) [N](#) [O](#) [P](#) [Q](#) [R](#) [S](#) [T](#) [U](#) [V](#) [W](#) [X](#) [Y](#) [Z](#)

ISO Paper 

J

Job Management Menu 

K

Keys

Action 

Cancel 

Form Feed & Cut 

Navigation 

Back 

Down 

Enter 

Menu 

Up 

L

Loading

Roll Media 

Sheet Media 

Loading Roll Media Problems 

Loading Sheet Media Problems 

Long-Axis Image is Clipped 

M

Margins 

margins 

margins specifications 

Marks or Scratches on Glossy Paper 

matte film 

Media

Cutter 

Handling 

Media Types

Additional Information 

Combinations 

Print Quality Selection 

Roll

Installing 

Loading 

Removing from Printer 

Removing from Spindle 

Unloading 

Sheet

Loading 

Unloading 

Which Edge First 

Which Side Up 

media 

choice 

media types

bright white inkjet paper 

canvas 

clear film 

coated paper 

double sided paper 

heavy coated paper 

high-gloss photo 

matte film 

natural tracing paper 



A B C D E F G H I J K L M N O P Q R S T U V W X Y Z

plain paper 

supported 

translucent bond 

vellum 

Media Problems

Blurred Lines 

Clearing Jam 

General Rules 

Ink Bleeds 

Loading

Roll Media 

Sheet Media 

Marks or Scratches 

Output 

Warped Lines 

media sizes specifications 

media types 

memory 

memory specifications 

memory upgrades 

Menu

Ink 

Job Manangement 

Paper 

Menu Key 

Menu Set-up 

Menu Structure 

merge 

Mirror Image 

N

natural tracing paper 

Navigating the Menu System 

Navigation

Example 

Navigation Keys 

Nesting 

Control 

What Pages Qualify for Nesting 

When does the Printer Try to Nest Pages 

When Queueing is Off 

nesting 

and automatic rotation 

and page size 

and rotation 

choosing the method 

if queueing off 

pages qualifying for 

setting the space 

turning on or off 

wait time 

when used 

nesting pages 

network interface

changing settings 

networks and graphics language 

Normal 

Print Resolution 





A B C D E F G H I J K L M N O P Q R S T U V W X Y Z

O

Obtaining Roll Media Information 

Obtaining Sheet Media Information 

One Image Overlays Another on Same Sheet 

operational specifications 

ordering accessories 

Other Sources of Information for Incorrect Printed Image 

Output Contains Only a Partial Print 

overlapping lines

changing treatment of 

P

Page Description 

Page Format

Inked Area 

Margins 

Printing Area 

Size 

page format

inked area 

margins 

page size 

Page Format or Rotate have No Effect 

Page Size 

Nesting 

page size 

adjusting 

and clipped images 

and nesting 

Palette 

palettes

changing colors 

changing pen width 

internal 

viewing current settings 

paper

important points 

Paper Menu 

parallel (Bi-Tronics/Centronics) interface specifications 

parallel interface 

Pen Settings have No Effect 

pen widths

changing 

Pens 

physical specifications 

plain paper 

Pocket Guide 

PostScript scaling 

PostScript Upgrade 

power specifications 

print appearance

controlling 

Print Cancel 

Print Distorted or Unintelligible 

Print is a Mirror Image of Original 

Print is Completely Blank 



A B C D E F G H I J K L M N O P Q R S T U V W X Y Z

Print Quality 

print quality

printing speeds and print quality 

settings 

Print Resolution

Best 

Fast 

Normal 

print resolution 

Printable Area

Architectural Paper 

ISO Paper 

Printed Image Incorrect





Image is in One Portion of the Printing Area 

Image is Unexpectedly Rotated 

One Image Overlays Another on Same Sheet 

Other Sources of Information 

Page Format or Rotate have No Effect 

Pen Settings have No Effect 

Print Distorted or Unintelligible 

Print is a Mirror Image of Original 

Printer Configuration

Graphics Language 

Printer does not Print 

Printer Seems Too Slow 

Printhead

Alignment 

Problem Inserting 

Problems after replacement 

Replacement 

Statistics 

Printheads

HP Ink Supplies 

printheads

HP Ink Supplies 

Printing Area 

printing area 

Problems

Banding 

Color Accuracy Configuration 

Color Alignment 

Color Consistency 

Configuration Correction 





Finding the Source 

Image Quality 

Incomplete Lines 

Ink Supply

After replacement of Printhead 

Inserting the Ink Cartridge 

Inserting the Printhead 

Solutions 

Solving 

Stepped Lines 

Troubleshooting 

PS scale option 

Q

Queue



[A](#) [B](#) [C](#) [D](#) [E](#) [F](#) [G](#) [H](#) [I](#) [J](#) [K](#) [L](#) [M](#) [N](#) [O](#) [P](#) [Q](#) [R](#) [S](#) [T](#) [U](#) [V](#) [W](#) [X](#) [Y](#) [Z](#)

[Copying Jobs](#)

[Deleting Job](#)

[Description](#)

[Identifying Job](#)

[Job Priority](#)

[Management](#)

[Position](#)

queue

[deleting a job from](#)

[identifying a page in](#)

[making copies of a page in](#)

[page position in](#)

[printing a waiting file](#)

[prioritizing a job in](#)

[Queueing Turned OFF](#)

[Queueing Turned ON](#)

R

[recalibrating the printer](#)

Removing

Roll Media

[from Printer](#)

[from Spindle](#)

[Repacking Poster](#)

Replacing

[Cutter](#)

[Ink Cartridge](#)

[Printhead](#)

[resolution specifications](#)

[resolution. See print resolution](#)

Roll Media

[Information](#)

[Installing](#)

[Loading](#)

[Removing from Printer](#)

[Removing from Spindle](#)

[Unloading](#)

[Rotating an Image](#)

S

Scaling

[Factors](#)

[Fit to page](#)

scaling

[printed images](#)

[Scaling Image](#)

[Set-up Menu](#)

[Setup Poster](#)

Sheet Media

[Information](#)

[Loading](#)

[Unloading](#)

[Which Edge First](#)

[Which Side Up](#)

[software applications](#)

[Solutions to Problems](#)

specifications

[accuracy](#)



[A](#) [B](#) [C](#) [D](#) [E](#) [F](#) [G](#) [H](#) [I](#) [J](#) [K](#) [L](#) [M](#) [N](#) [O](#) [P](#) [Q](#) [R](#) [S](#) [T](#) [U](#) [V](#) [W](#) [X](#) [Y](#) [Z](#)

[acoustic](#)
[cables](#)
[ecological](#)
[environmental](#)
[functional](#)
[graphics languages supported](#)
[interface](#)
[margins](#)
[media sizes](#)
[memory](#)
[operational](#)
[parallel \(Bi-Tronics/Centronics\) interface](#)
[physical](#)
[power](#)
[resolution](#)

[Speed and Print Quality](#)
[Stepped Lines Problems](#)
[supported media types](#)

T

[translucent bond](#)
[Troubleshooting](#)
[Procedure](#)
[types of media](#)

[Typical Drying Times](#)
[Typical Printing Times](#)

U

[Universal Serial Bus](#)
[Unloading](#)

[Roll Media](#)
[Sheet Media](#)
[Up Key](#)
[upgrading memory](#)
[USB](#)
[user interface](#)
[User's Reference Guide](#)
[animation](#)
[buttons](#)
[how to us](#)
[Navigation](#)
[next page button](#)
[previous page button](#)
[navigation](#)
[back button](#)
[exit button](#)
[home button](#)
[print button](#)
[related information](#)
[tabs](#)

V

[vellum](#)

W

[Warped Lines](#)
[Web Page](#)
[When to Replace HP Ink Supplies](#)

